

Alpha-4L Series

Direct Thermal Portable Bar Code Printer

**USER'S
MANUAL**

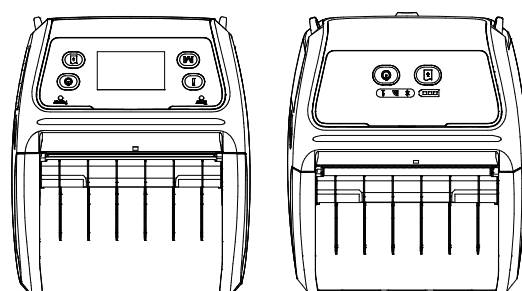

Copyright Information

©2013 TSC Auto ID Technology Co., Ltd,

The copyright in this manual, the software and firmware in the printer described therein are owned by TSC Auto ID Technology Co., Ltd, All rights reserved.

CG Triumvirate is a trademark of Agfa Corporation. CG Triumvirate Bold Condensed font is under license from the Monotype Corporation. Windows is a registered trademark of Microsoft Corporation.

All other trademarks are the property of their respective owners.

Information in this document is subject to change without notice and does not represent a commitment on the part of TSC Auto ID Technology Co. No part of this manual may be reproduced or transmitted in any form or by any means, for any purpose other than the purchaser's personal use, without the expressed written permission of TSC Auto ID Technology Co.

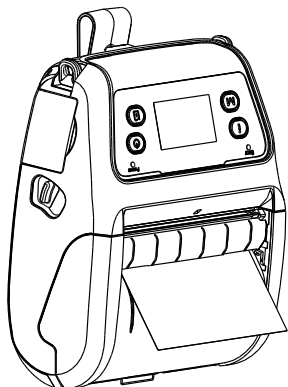

Agency Compliance and Approvals



EN 55022/24, IEC 61000-3-3, IEC 61000-3-2
EN 300328, EN 301489



Part 15B/C



EN 60950-1



GB 9254
GB 4943.1
GB 17625.1

SRRC

Wichtige Sicherheits-Hinweise

1. Bitte lesen Sie diese Hinweis sorgfältig durch.
2. Heben Sie diese Anleitung für den späteren Gebrauch auf.
3. Vor jedem Reinigen ist das Gerät vom Stromnetz zu trennen. Verwenden Sie keine Flüssig-oder Aerosolreiniger. Am besten eignet sich ein angefeuchtetes Tuch zur Reinigung.
4. Die Netzanschluß-Steckdose soll nahe dem Gerät angebracht und leicht zugänglich sein.
5. Das Gerät ist vor Feuchtigkeit zu schützen.
6. Bei der Aufstellung des Gerätes ist auf sicheren Stand zu achten. Ein Kippen oder Fallen könnte Beschädigungen hervorrufen.
7. Beachten Sie beim Anschluß ans Stromnetz die Anschlußwerte.
8. Dieses Gerät kann bis zu einer Außentemperatur von maximal 40°C betrieben werden.

Battery safety warning:

DO NOT throw the battery in fire.

DO NOT short circuit the contacts.

DO NOT disassemble the battery.

DO NOT throw the battery in municipal waste.

The symbol of the crossed out wheeled bin indicates that the battery should not be placed in municipal waste.

CAUTION

Risk of explosion if battery is replaced by an incorrect type.

Dispose of used batteries according to the instructions.

“VORSICHT”

Explosionsgefahr bei unsachgemäßen Austausch der Batterie. Ersatz nur durch denselben oder einem vom Hersteller empfohlenem ähnlichen Typ. Entsorgung gebrauchter Batterien nach Angaben des Herstellers.

Class B:

FEDERAL COMMUNICATIONS COMMISSION INTERFERENCE STATEMENT

This equipment has been tested and found to comply with the limits for a Class B digital device, pursuant to part 15 of the FCC Rules. These limits are designed to provide reasonable protection against harmful interference in a residential installation. This equipment generates, uses and can radiate radio frequency energy and, if not installed and used in accordance with the instructions, may cause harmful interference to radio communications. However, there is no guarantee that interference will not occur in a particular installation. If this equipment does cause harmful interference to radio or television reception, which can be determined by turning the equipment off and on, the user is encouraged to try to correct the interference by one or more of the following measures:

- Reorient or relocate the receiving antenna.
- Increase the separation between the equipment and receiver.
- Connect the equipment into an outlet on a circuit different from that to which the receiver is connected.
- Consult the dealer or an experienced radio/ TV technician for help.

This device complies with Part 15 of the FCC Rules. Operation is subject to the following two conditions: (1) This device may cause harmful interference, and (2) this device must accept any interference received, including interference that may cause undesired operation.

CAUTION:

Any changes or modifications not expressly approved by the grantee of this device could void the user's authority to operate the equipment.

RF exposure warning (WiFi)

This equipment must be installed and operated in accordance with provided instructions and must not be co-located or operating in conjunction with any other antenna or transmitter. End-users and installers must be providing with antenna installation instructions and transmitter operating conditions for satisfying RF exposure compliance.

SAR Value: 0.663 W/kg

RF exposure warning (For Bluetooth)

The equipment complies with FCC RF exposure limits set forth for an uncontrolled environment.

The equipment must not be co-located or operating in conjunction with any other antenna or transmitter.

Canada, Industry Canada (IC) Notices

This Class B digital apparatus complies with Canadian ICES-003 and RSS-210. Operation is subject to the following two conditions: (1) this device may not cause interference, and (2) this device must accept any interference, including interference that may cause undesired operation of the device.

Radio Frequency (RF) Exposure Information

The radiated output power of the Wireless Device is below the Industry Canada (IC) radio frequency exposure limits. The Wireless Device should be used in such a manner such that the potential for human contact during normal operation is minimized.

This device has been evaluated for and shown compliant with the IC Specific Absorption Rate ("SAR") limits when installed in specific host products operated in portable exposure conditions. **(For WiFi)**

This device has also been evaluated and shown compliant with the IC RF Exposure limits under portable exposure conditions. (antennas are less than 20 cm of a person's body). **(For Bluetooth)**

Canada, avis d'Industry Canada (IC)

Cet appareil numérique de classe B est conforme aux normes canadiennes ICES-003 et RSS-210.

Son fonctionnement est soumis aux deux conditions suivantes : (1) cet appareil ne doit pas causer d'interférence et (2) cet appareil doit accepter toute interférence, notamment les interférences qui peuvent affecter son fonctionnement.

Informations concernant l'exposition aux fréquences radio (RF)

La puissance de sortie émise par l'appareil de sans fil est inférieure à la limite d'exposition aux fréquences radio d'Industry Canada (IC). Utilisez l'appareil de sans fil de façon à minimiser les contacts humains lors du fonctionnement normal.

Ce périphérique a été évalué et démontré conforme aux limites SAR (Specific Absorption Rate – Taux d'absorption spécifique) d'IC lorsqu'il est installé dans des produits hôtes particuliers qui fonctionnent dans des conditions d'exposition à des appareils portables. **(For WiFi)**

Ce périphérique a également été évalué et démontré conforme aux limites d'exposition aux RF d'IC dans des conditions d'exposition à des appareils portables. (les antennes sont moins de 20 cm du corps d'une personne). **(For Bluetooth)**

电池安全警告:

- ◎ 勿将电池扔于火中。
- ◎ 勿将电池接点短路。
- ◎ 不可拆解电池。
- ◎ 不乱将电池当成一般废弃物处理。
- ◎ 打叉的垃圾桶符号表示电池不应该被放置到一般废弃堆中。

注意:

- ◎ 更换不正确型号类型的电池, 将产生爆炸危险。
- ◎ 请根据使用说明处理用过的电池。

Contents

- 1. Introduction1
 - 1.1 Product Introduction1
 - 1.2 Product Features..... 2
 - 1.2.1 Printer Standard Features** 2
 - 1.2.2 Printer Optional Features**3
 - 1.3 General Specifications 5
 - 1.4 Print Specifications..... 5
 - 1.5 Media Specifications 6
- 2. Operations Overview..... 7
 - 2.1 Unpacking and Inspection..... 7
 - 2.2 Printer Overview 8
 - 2.2.1 Front View**8
 - 2.2.2 Rear View**9
 - 2.3 Operator Control 10
 - 2.3.1 LED Indication and Keys** 10
 - 2.3.2 LED Indication and Keys for LCD (Option)**.....11
- 3. Setup12
 - 3.1 Install the Belt Clip and Battery12
 - 3.2 Charge the Battery.....13
 - 3.2.1 Charge the Battery** 13
 - 3.3 Loading the Media.....14
 - 3.3.1 Loading the Media** 14
 - 3.3.2 Loading Media in Peel-off Mode** 16
 - 3.3.3 Loading the Fan-fold/External Media**..... 19
 - 3.3.4 Loading the Linerless Media (Option)** 21
 - 3.4 Connecting the Printer 22
 - 3.4.1 Cable Communications**22
 - 3.4.2 Wireless Communications with Bluetooth**.....22
 - 3.4.3 Wireless Communications with Wi-Fi (Option)**23
 - 3.5 Install the IP54-rated Environmental Case with Shoulder Strap (Option) 24
 - 3.6 Install the Adapter for 0.75” and 1” Paper Core (Option) 25

3.7 Install the Belt Strap (Option/ Standard for linerless model).....	27
4. Power-on Utilities	29
4.1 Power-on Utility for Standard Panel.....	29
4.1.1 Media Sensor Calibration	30
4.1.2 Self-test and Dump Mode	30
4.1.3 Printer Initialization	31
4.2 Power-on Utility for LCD Panel (Option)	32
4.2.1 Media Sensor Calibration	32
4.2.2 Self-test and Dump Mode	33
4.2.3 Printer Initialization	34
4.3 Self-test.....	35
4.4 Dump mode.....	36
4.5 Printer defaults	37
5. Diagnostic Tool.....	38
5.1 Start the Diagnostic Tool	38
5.2 Printer Function	39
5.3 Setting Bluetooth by Diagnostic Tool	40
5.4 Setting Wi-Fi by Diagnostic Tool (Option)	41
6. LCD Menu Function (Option).....	42
6.1 How to use the LCD to set the printer.....	42
6.2 Main Menu Overview	44
6.3 Setup.....	45
6.3.1 Printer Setup	45
6.3.1-1 Printer setup for TSPL2	45
6.3.1-2 Printer setup for ZPL2	47
6.3.2 Sensor	49
6.3.3 Serial Comm.	50
6.3.4 Wireless LAN	51
6.3.5 Bluetooth	52
6.3.6 Date Time	52
6.3.7 Display	53
6.4 File Manager	54
6.5 Diagnostics.....	55

6.5.1 Print Config.....	55
6.5.2 Dump Mode	55
6.5.3 Battery	56
6.5.4 Print Head.....	56
6.6 Language	57
6.7 Service.....	57
7. Troubleshooting	58
8. Maintenance.....	60
Revise History.....	61

1. Introduction

1.1 Product Introduction

Thank you very much for purchasing TSC bar code printer.

Enjoy TSC's reputation for cost-efficient, high durability printers with the Alpha-4L economical receipt printer. The Alpha-4L is a comfortable, light-weight printer capable of working with any mobile receipt printing application where you need quick, simple receipts on demand. Our Alpha-4L is designed for a rough life, inside the IP54-rated environmental case to resist dust and water and with its rubber over-mold design prepared to take up to a five foot fall and keep printing. These small and light printers can be worn comfortably for a full shift, without interfering with the user's tasks. Use USB, Bluetooth, optional 802.11 b/g/n Wireless or serial to connect to a mobile computer or even a smart phone and produce clear easy-to-read receipts hour after hour.

This document provides an easy reference for operating the Alpha-4L.

To print label formats, please refer to the instructions provided with your labeling software; if you need to write the custom programs, please refer to the TSPL/TSPL2 programming manual that can be found on the accessories CD-ROM or on TSC website at <http://www.tscprinters.com>.

- Applications
 - Portable point of sale
 - Retail item marking, markdowns, shelf labeling & shelf talkers
 - Labels for shipping & receiving
 - Inventory control
 - Cross-docking
 - Pick, pack & apply operations
 - Print pick tickets
 - Logistics receipts

1.2 Product Features

1.2.1 Printer Standard Features

The printer offers the following standard features.

Product standard feature		
Direct thermal printing		
Black mark reflective sensor (center position , black mark in back side)		
Gap transmissive sensor (Fixed, center of offset 2.75 mm to right from center)		
Head open sensor		
Peeler sensor		
2 operation buttons (On/off and feed)		
3 LEDs for printer status, 3 LEDs for battery status		
USB 2.0 (full speed) interface		
Class 2 Bluetooth 2.1 module		
32 MB SDRAM memory		
16 MB FLASH memory		
Micro SD card reader for memory expansion up to SDHC 4G (max.)		
DC 7.2V/5800 mAh Li-ion rechargeable battery		
Real time clock		
Powerful 32 bit 200 MHz RISC processor		
Eltron [®] EPL and Zebra [®] ZPL emulation languages support		
Internal 8 alpha-numeric bitmap fonts		
Internal Monotype Imaging [®] true type font engine with one CG Triumvirate Bold Condensed scalable font		
Fonts and bar codes can be printed in any one of the four directions (0, 90,180, 270 degree)		
Downloadable fonts from PC to printer memory		
Downloadable firmware upgrades		
Bar code, graphics/image printing		
Supported bar code		Supported image
1D bar code	2D bar code	BITMAP, BMP, PCX (Max. 256 colors graphics)
Code128 subsets A.B.C, Code128UCC, EAN128, Interleave 2 of 5, Code 39, Code 93, EAN-13, EAN-8, Codabar, POSTNET, UPC-A, UPC-E, EAN and UPC 2(5) digits, MSI, PLESSEY, China Post, ITF14, EAN14, Code 11, TELPEN, PLANET, Code 49, Deutsche Post Identcode, Deutsche Post Leitcode, LOGMARS	CODABLOCK F mode, DataMatrix, Maxicode, PDF-417, Aztec, MicroPDF417, QR code, RSS Barcode (GS1 Databar)	

Code page

- Codepage 437 (English - US)
- Codepage 737 (Greek)
- Codepage 850 (Latin-1)
- Codepage 852 (Latin-2)
- Codepage 855 (Cyrillic)
- Codepage 857 (Turkish)
- Codepage 860 (Portuguese)
- Codepage 861 (Icelandic)
- Codepage 862 (Hebrew)
- Codepage 863 (French Canadian)
- Codepage 864 (Arabic)
- Codepage 865 (Nordic)
- Codepage 866 (Russian)
- Codepage 869 (Greek 2)
- Codepage 950 (Traditional Chinese)
- Codepage 936 (Simplified Chinese)
- Codepage 932 (Japanese)
- Codepage 949 (Korean)
- Codepage 1250 (Latin-2)
- Codepage 1251 (Cyrillic)
- Codepage 1252 (Latin-1)
- Codepage 1253 (Greek)
- Codepage 1254 (Turkish)
- Codepage 1255 (Hebrew)
- Codepage 1256 (Arabic)
- Codepage 1257 (Baltic)
- Codepage 1258 (Vietnam)
- ISO-8859-1: Latin-1 (Western European)
- ISO-8859-2: Latin-2 (Central European)
- ISO-8859-3: Latin-3 (South European)
- ISO-8859-4: Latin-4 (North European)
- ISO-8859-5: Cyrillic
- ISO-8859-6: Arabic
- ISO-8859-7: Greek
- ISO-8859-8: Hebrew
- ISO-8859-9: Turkish
- ISO-8859-10: Nordic
- ISO-8859-15: Latin-9
- UTF-8

1.2.2 Printer Optional Features

The printer offers the following optional features.

Product option feature	User option	Factory option
2" LCD (Liquid crystal display), 128 x 64 pixels resolution w/white LED backlight (with 4 buttons and 2 LEDs)		<input type="radio"/>
WiFi 802.11 b/g/n		<input type="radio"/>
Zebra® CPCL emulation language support		<input type="radio"/>
Media sensor position (position selectable – right/left/center position-factory adjustment, default – center position)		<input type="radio"/>
Linerless kit		<input type="radio"/>

Mini USB cable	<input type="radio"/>	
Mini USB to RS-232 (serial) converter cable	<input type="radio"/>	
IP54-rated environmental case with shoulder strap (for standard model)	<input type="radio"/>	
IP54-rated environmental case (for standard model)	<input type="radio"/>	
IP54-rated environmental case with shoulder strap (for linerless model)	<input type="radio"/>	
IP54-rated environmental case (for linerless model)	<input type="radio"/>	
Shoulder strap	<input type="radio"/>	
Vehicle power adaptor	<input type="radio"/>	
DC 7.2V/5800 mAh Li-ion rechargeable battery	<input type="radio"/>	
Charger station 1 cell	<input type="radio"/>	
Charger station 4 cell	<input type="radio"/>	
Belt strap (standard for linerless model)	<input type="radio"/>	
Adapter for 0.75" & 1" paper core (standard for linerless model)	<input type="radio"/>	

1.3 General Specifications

General Specifications										
Physical dimensions	160 mm (W) x 191.6 mm (H) x 79 mm (D)									
Mechanism	Plastic with rubber over molded									
Weight	0.945 kg (w/o battery)									
Power	External power adapter Input: AC 100-240V Output: DC 12V 1A									
Environmental condition	Operation: -10 ~ 50°C (14 ~ 122°F) Storage: -40 ~ 60 °C (-40 ~ 140°F) Relative humidity: 10 ~ 90% non-condensing IP54 w/ IP54-rated environmental case Drop 1.5m (5ft) Drop 1.8m (6.5ft) w/ IP54-rated environmental case									
Battery Spec	<ul style="list-style-type: none"> • Charging time: 5~6 hr • Standby mode (Bluetooth): up to 55 hr • Standby mode (Wi-Fi): up to 40 hr • Printing: one label per 2 minutes, <table border="1" style="margin-left: 20px;"> <thead> <tr> <th>Condition</th> <th>Endurance (hr)</th> <th>4"x6" Labels</th> </tr> </thead> <tbody> <tr> <td>Density 3</td> <td>26</td> <td>780</td> </tr> <tr> <td>Density 8</td> <td>21</td> <td>650</td> </tr> </tbody> </table>	Condition	Endurance (hr)	4"x6" Labels	Density 3	26	780	Density 8	21	650
Condition	Endurance (hr)	4"x6" Labels								
Density 3	26	780								
Density 8	21	650								
Charging capability	<u>Internal charging capability (battery-in)</u> Auto-switching AC adapter 12-24VDC automobile cigarette lighter plug <u>External charging capability (battery-out)</u> 1 battery charger station 4 battery charger station									

1.4 Print Specifications

Print Specifications	
Print head resolution (dots per inch/mm)	203 dots/inch (8 dots/mm)
Printing method	Direct thermal
Dot size (width x length)	0.125 x 0.125 mm (1 mm = 8 dots)
Print speed (inches per second)	Max. 4 ips (100 mm/sec) 2,3 ips for peeler mode
Max. print width	4.09" (104 mm)
Max. print length	90" (2286 mm)
Printout bias	Vertical: 1 mm max. Horizontal: 1 mm max.

1.5 Media Specifications

Media Specifications	
Media roll capacity	Max. 2.65" (67.3 mm) OD
Media core diameter	12.7 mm ~ 25.4 mm (0.5" ~ 1") ID core
Media type	Continuous, die-cut, black mark, External fan-fold, receipt, Linerless label (w/ linerless kit)
Media wound type	Outside wound
Media width	50.8 mm ~ 112 mm
Media thickness	0.055 mm ~ 0.165 mm
Label length	12.7 mm ~ 2286 mm
Label length (peeler mode)	25.4 ~ 152.4 mm (1" ~ 6")
External fan-fold media	Stack height: 70 mm (2.75") Page length: 152 mm ~ 305 mm (6" ~ 12")
Black mark	Min. 8 mm (W) x 2 mm (H)
Gap height	Min. 2 mm

2. Operations Overview

2.1 Unpacking and Inspection

This printer has been specially packaged to withstand damage during shipping. Please carefully inspect the packaging and printer upon receiving the bar code printer. Please retain the packaging materials in case you need to reship the printer.

Unpacking the printer, the following items are included in the carton.

- One printer unit
- One Li-ion rechargeable battery (5800 mAh)
- One Windows labeling software/Windows driver CD disk
- One quick installation guide
- One auto-switching AC adaptor
- One belt clip

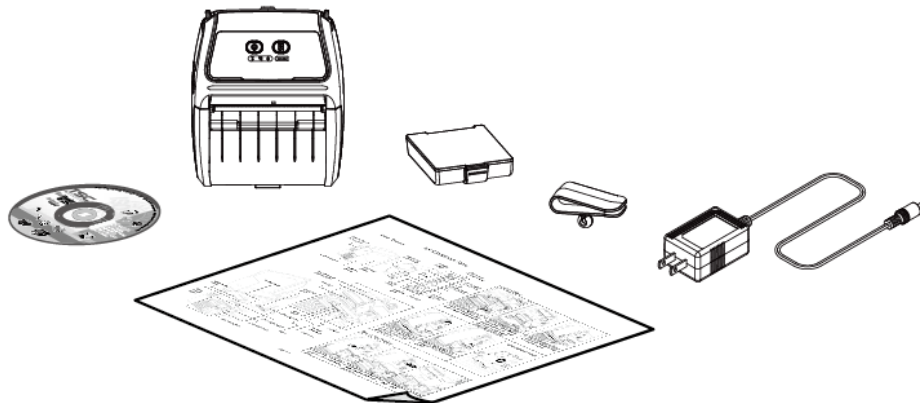

If any parts are missing, please contact the Customer Service Department of your purchased reseller or distributor.

2.2 Printer Overview

2.2.1 Front View

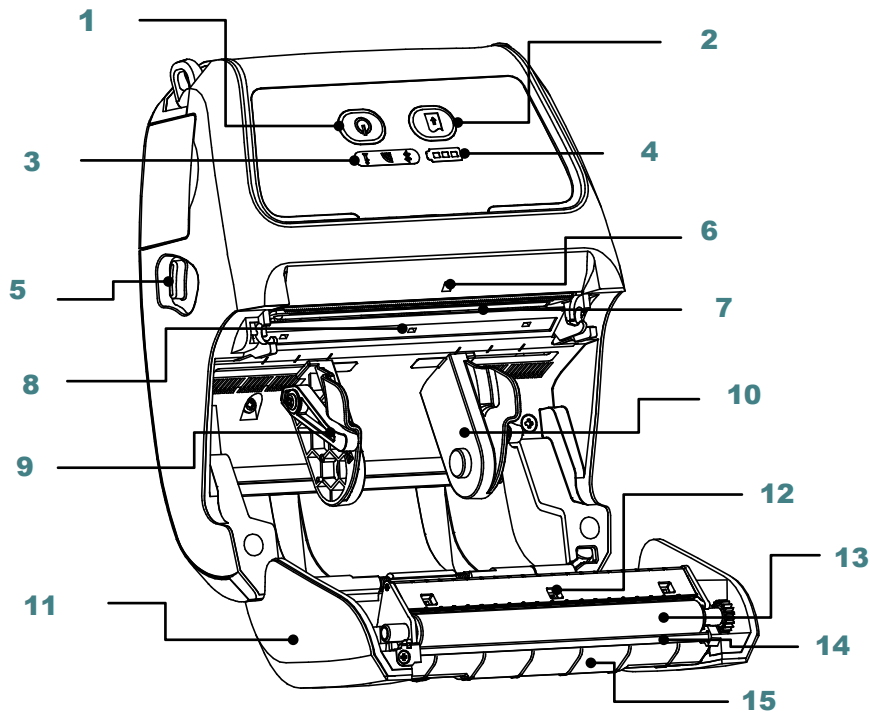

1. Power on/off button
2. Feed button
3. Printer status LED indicator
4. Battery status LED indicator
5. Media cover release button
6. Peel-off sensor (Without for linerless model)
7. Print head
8. Transmissive sensor – Gap sensor
9. Media holder lock switch
10. Media holder
11. Media cover
12. Reflective sensor – Black mark sensor
13. Platen roller
14. Tear/Peeler bar (Without for linerless model)
15. Peeler module

Note:

* The media sensor position is selectable by factory adjustment. Please refer to this figure for default settings. (Default – center position)

* For LCD control panel (option), please refer to [subsection 2.3.2](#) for more details.

2.2.2 Rear View

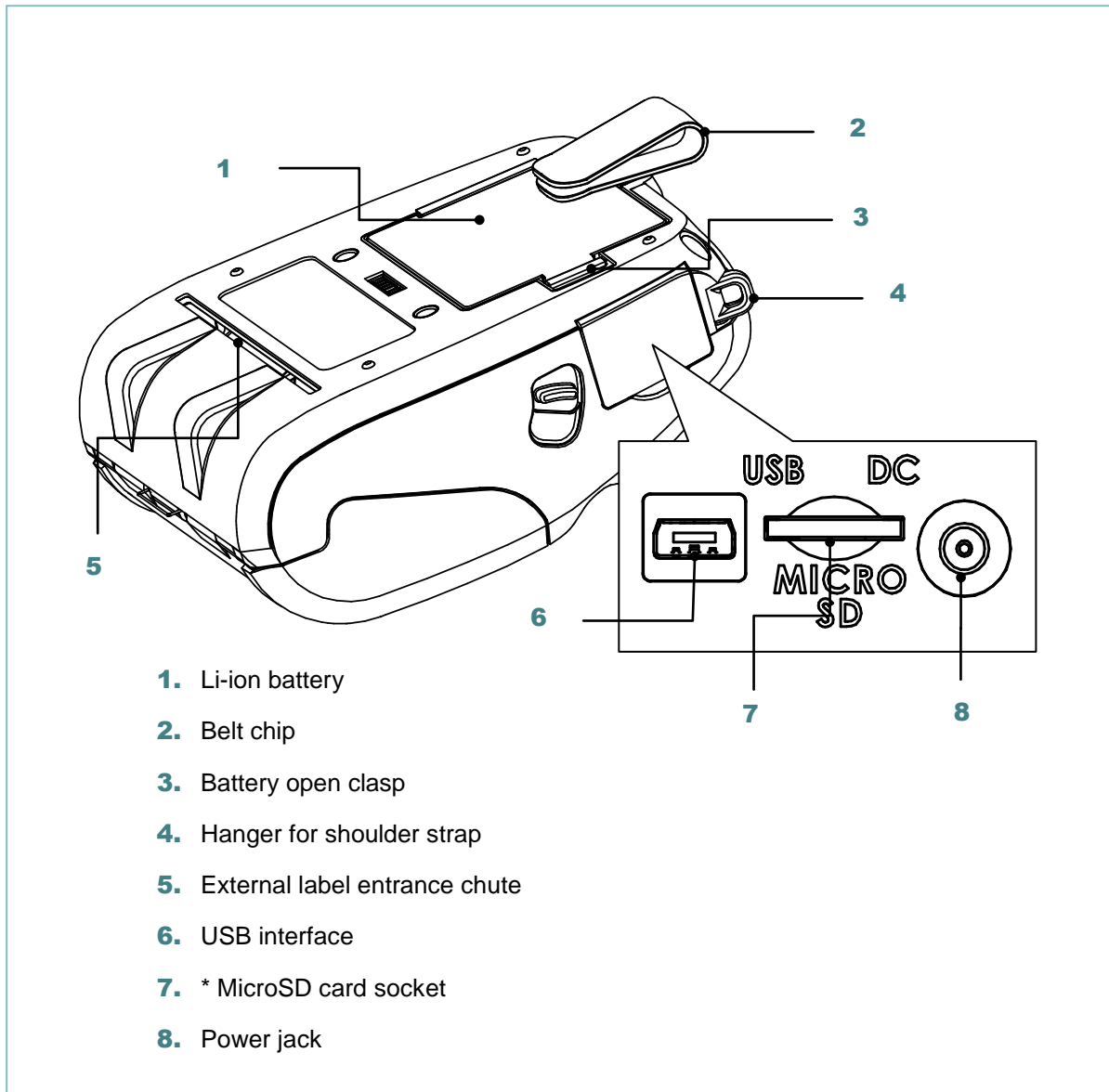

Note:

* Recommended MicroSD card specification.

SD card spec	SD card capacity	Approved SD card manufacturer
V1.0, V1.1	MicroSD 128 MB	Transcend, Panasonic
V1.0, V1.1	MicroSD 256 MB	Transcend, Panasonic
V1.0, V1.1	MicroSD 512 MB	Transcend, Panasonic
V1.0, V1.1	MicroSD 1 GB	Transcend, Panasonic
V2.0 SDHC CLASS 6	MicroSD 4 GB	Transcend
- The DOS FAT file system is supported for the SD card. - Folders/files stored in the SD card should be in the 8.3 filename format		

2.3 Operator Control

2.3.1 LED Indication and Keys

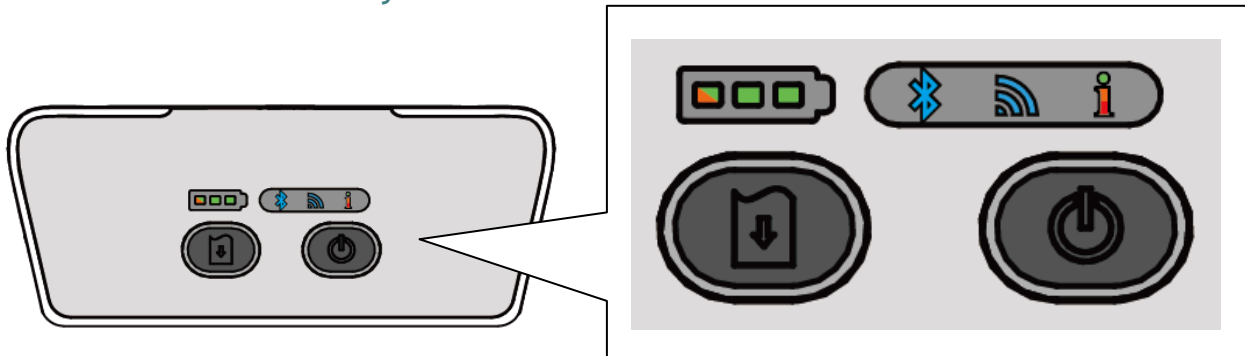

Keys	Function	
	<ul style="list-style-type: none"> - Press and hold for 2-3 seconds to turn on the printer - Press and hold for 2-3 seconds to turn off the printer 	
	<ul style="list-style-type: none"> - Ready status: Feed one label - Printing status: Pause the print job 	
LEDs	Status	Indication
		Full charged
		2/3 charged level
		1/3 charged level
		Low battery
	Amber (solid)	Battery is charging
	Blue (solid)	Bluetooth device is ready
	Blue (blinking)	Bluetooth device is communicating
	Blue (solid)	WiFi device is ready
	Blue (blinking)	WiFi device is communicating
	Note: WiFi device is optional.	
	Off	Printer is ready
	Green (blinking)	<ul style="list-style-type: none"> - Printer is paused - Printer is downloading data
	Red (solid)	<ul style="list-style-type: none"> - Media cover is open - Out of memory
	Red (blinking)	<ul style="list-style-type: none"> - No paper - Paper jam
	Amber (solid)	<ul style="list-style-type: none"> - Clean data - Printer is busy

2.3.2 LED Indication and Keys for LCD (Option)

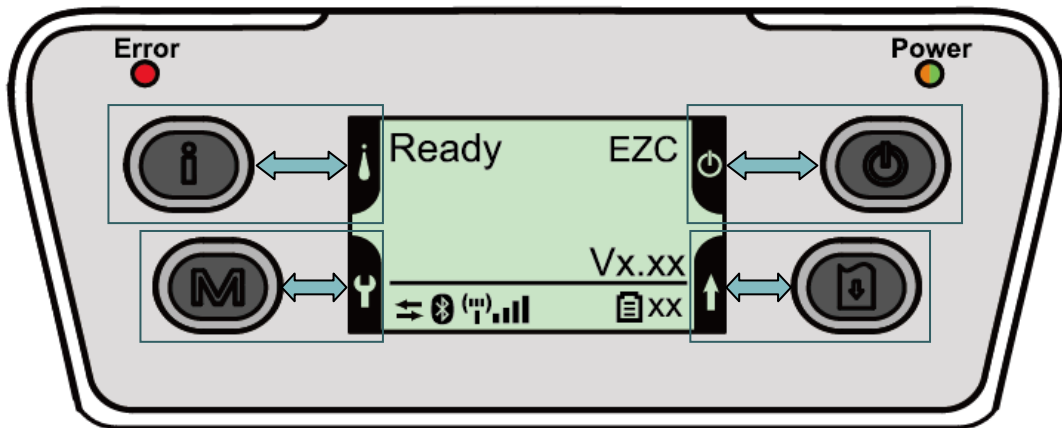

Keys	Function	
	<ul style="list-style-type: none"> - Display the printer information - Button for LCD setting menu 	
	<ul style="list-style-type: none"> - Enter the printer setting menu - Button for LCD setting menu 	
	<ul style="list-style-type: none"> - Press and hold for 2-3 seconds to turn on the printer - Press and hold for 2-3 seconds to turn off the printer - Button for LCD setting menu 	
	<ul style="list-style-type: none"> - Ready status: Feed one label - Printing status: Pause the print job - Button for LCD setting menu 	
LEDs	Status	Indication
Error	Off	Printer is ready
	Red (solid)	<ul style="list-style-type: none"> - Media cover is open - Out of memory - Clean data - Printer is busy
	Red (blinking)	<ul style="list-style-type: none"> - No paper - Paper jam
Power	Off	Printer power is turned off
	Green (solid)	<ul style="list-style-type: none"> - Printer power is turned on - Battery is full charged
	Green (blinking)	Low battery
	Amber (solid)	Battery is charging
LCD	Indication	
	Printer has been connected with cable	
	Bluetooth devices have been paired	
	Wi-Fi device has been connected	
	Battery capacity %	

Note: Please refer to the [section 6](#) for more details about LCD.

3. Setup

3.1 Install the Belt Clip and Battery





	<p>1. Insert the belt clip first.</p>
	<p>2. Insert the left side to install the battery at the rear of the printer.</p>
	<p>3. Push the right side of the battery.</p>

Battery safety warning:
DO NOT throw the battery in fire. DO NOT short circuit the contacts.
DO NOT disassemble the battery. DO NOT throw the battery in municipal waste.
The symbol of the crossed out wheeled bin indicates that the battery should not be placed in municipal waste.

3.2 Charge the Battery

It takes 5~6 hours to fully charge the battery before the first time usage. The lifetime of the battery is 300 times for charge/discharge cycles.

3.2.1 Charge the Battery

	<p>1. The battery is installed into the printer.</p>
	<p>2. Open the interface cover and plug the power cord to the power jack.</p>
	<p>3. Plug the power cord into a properly power outlet.</p> <p>Note: Please switch OFF printer power prior to plug in the power cord to printer power jack. When the battery is charging, please do not remove the battery from the printer, otherwise, please re-plug the power cord into a power outlet.</p>
<p>Standard panel:</p>  <p>LCD panel: (option)</p> <p>Power</p> 	<p>4. When the battery is changing, the color of battery status LED indicator is solid amber.</p> <p>Note: The battery is completely charged and the amber of LED indicator will turn to green.</p>

3.3 Loading the Media

3.3.1 Loading the Media



1. Open the printer media cover by pressing the media cover release button.

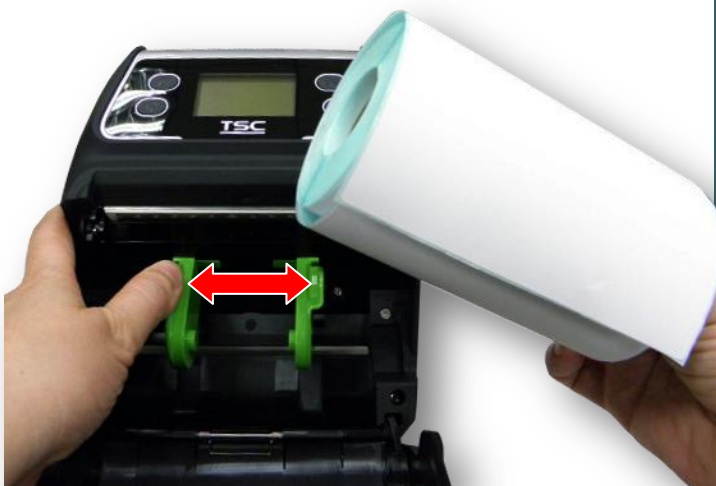

2. Pull the media holders apart to fit the label roll width.



3. Place the roll between the media holders and close them onto the core. Place the paper, printing side face up, and pull out enough paper over the print head.

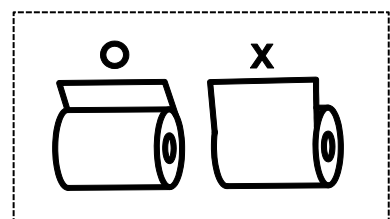



4. Press each side of media cover to close the media cover and make sure the media cover closed correctly.

Note:

* Please calibrate the gap/black mark sensor when changing media. Turn on the printer and open/close the media cover then it will calibrate the sensor automatically.

* Please refer to video on [TSC YouTube](#) or driver CD.

3.3.2 Loading Media in Peel-off Mode



1. Please refer to [subsection 3.3.1](#) to loading the media roll into the printer.

Note:
Please calibrate the gap/black mark sensor after loading media in peel-off mode. Turn on the printer and open/close the media cover then it will calibrate the sensor automatically.



2. Remove 1~2 labels from the liner.



3. Press each side of media cover to close the media cover and make sure the media cover closed correctly.



4. Feed the liner go through the peeler module. (as figure shown)



5. Pull the liner tightly.

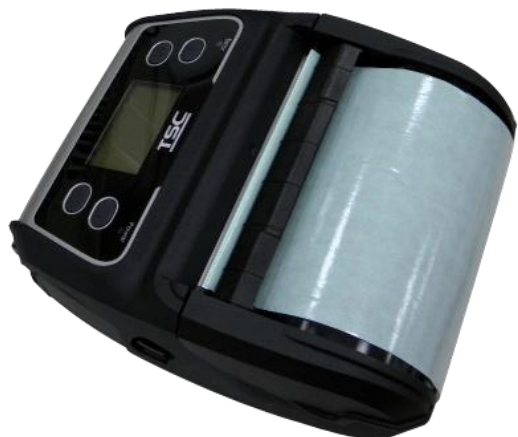

6. Move the peeler module to near the peeler bar by pushing each side of peeler module. (cover the platen roller)



7. Press down the peeler module to lock it.

Loose the peeler module in the reverse procedures:

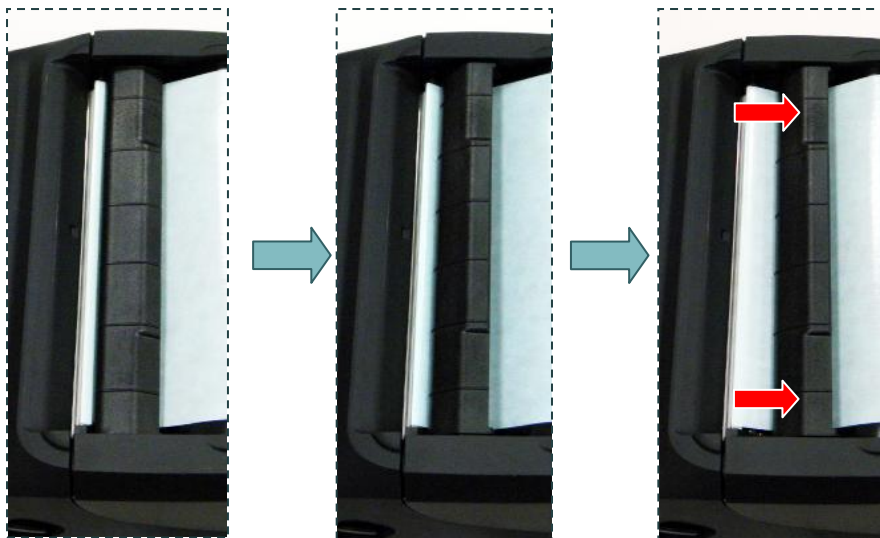

3.3.3 Loading the Fan-fold/External Media



1. Open the printer media cover by pressing the media cover release button. Pull the media holders apart to fit the media width.



2. Push down each side of media holder lock switch to fix the media holder.



3. Feed the media through the rear external label entrance chute. Place the paper, printing side face up.





4. Press each side of media cover to close the media cover and make sure the media cover closed correctly.

Note:

Please calibrate the gap/black mark sensor when changing media. Turn on the printer and open/close the media cover then it will calibrate the sensor automatically.

3.3.4 Loading the Linerless Media (Option)

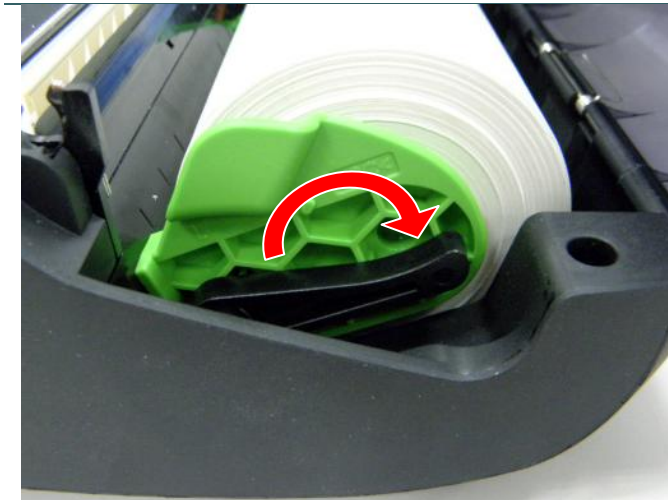

1. Please refer to [subsection 3.3.1](#) to loading the media roll into the printer.
2. Push down each side of media holder lock switch to fix the media holder for using linerless media.



3. Place the paper, printing side face up, and pull out enough paper over the print head.



4. Press each side of media cover to close the media cover and make sure the media cover closed correctly.

Note:

Please calibrate the gap/black mark sensor when changing media. Turn on the printer and open/close the media cover then it will calibrate the sensor automatically.

3.4 Connecting the Printer

The printer must establish communication with a host terminal which sends the data to be printed. There are three ways to connect for Alpha-4L series,

- * By a cable between the printer and its host terminal
- * By a Bluetooth short-range radio
- * By a Wireless LAN per 802.11 b/g (Option)

3.4.1 Cable Communications

USB connector (Printer)

USB/RS-232 connector (PC)

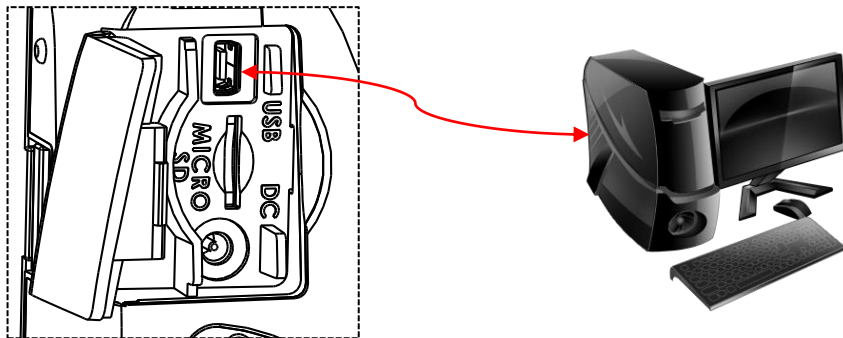

Open the interface cover and connect the printer to the computer/smart phone (host terminal) with USB cable. (USB to USB or USB to RS-232)

3.4.2 Wireless Communications with Bluetooth

1. Turn on the printer.
2. Open the Bluetooth device for host terminal to scan for printer's Bluetooth device.
3. Connect the Bluetooth devices. The Bluetooth LED will turn on blue (the Bluetooth icon will be shown for LCD panel) if devices have been paired.

Printer Bluetooth default	
Address	You can find this info from configuration (self-test) page, please refer to section 4 for how to print out the self-test.
Name	BT-SPP
PIN	0000

Note:

Please refer to [section 5.3](#) to change the name and PIN by DiagTool. If your printer supports the LCD, please refer the [section 6.3.5](#) to change the name and PIN directly.

3.4.3 Wireless Communications with Wi-Fi (Option)

You should set the WLAN settings via the cable for first using. Please refer to [section 5.4](#) to setting the Wi-Fi module. If your printer supports the LCD, please refer the [section 6.3.4](#) to set the WLAN settings.

3.5 Install the IP54-rated Environmental Case with Shoulder Strap (Option)

	<p>1. Open the case top cover.</p>
	<p>2. Put the printer into the case.</p>
	<p>3. Close the case top cover. The outside cover should be opened while printing.</p>

3.6 Install the Adapter for 0.75" and 1" Paper Core (Option)

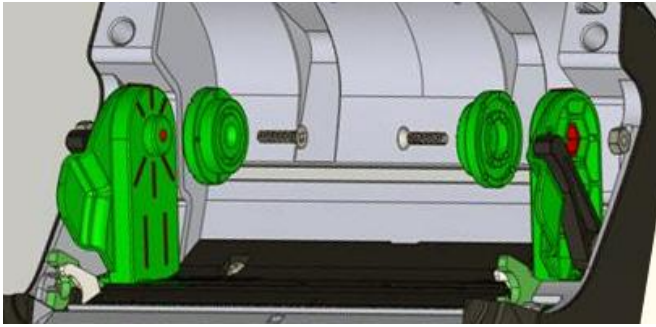

1. Check the parts.

- Adapter x 2
- Screw x 2
- Nut x 2



2. Put the nut on the media holder.

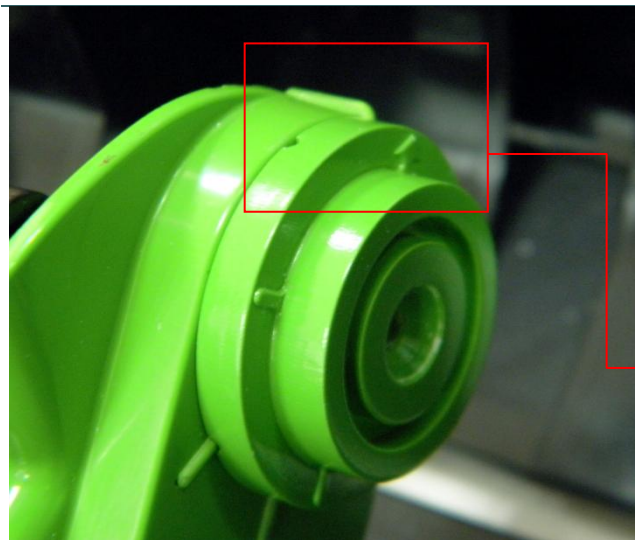

3. Make the arrow direction is as fig. to install the adapter.

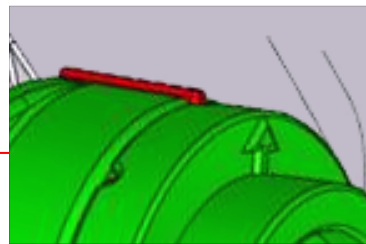

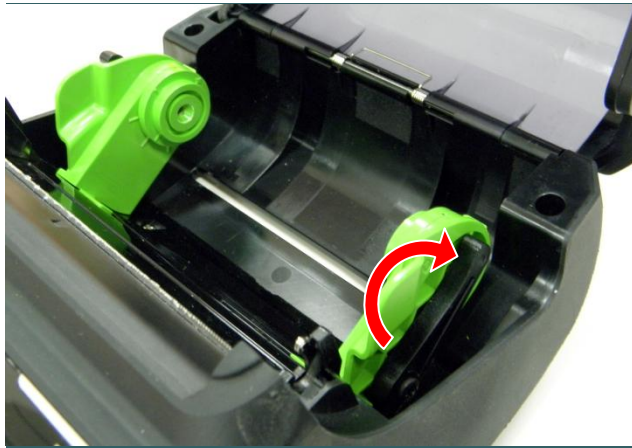

4. Pull the media holders apart. Push down another side of media holder lock switch to keep the media holder in max width.



5. Tighten the screw on nut for fixing the adapter on media holder.

Note: Press the nut with hand when tighten the screw.

3.7 Install the Belt Strap (Option/ Standard for linerless model)



1. Tighten 2 screws on the printer.



2. Pull up the belt strap to lock it on the screws.

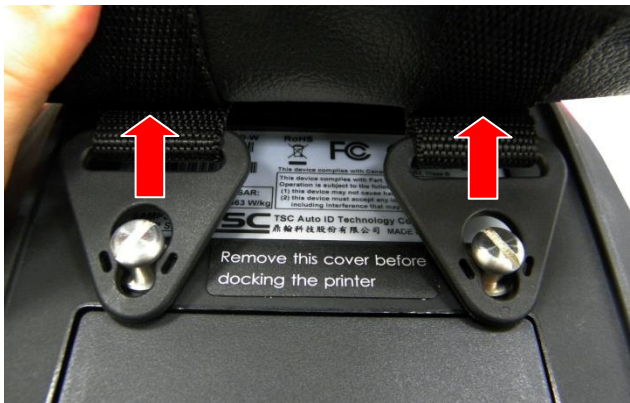

For linerless model



For standard model



3. Open the belt strap for using.



4. Power-on Utilities

There are three power-on utilities to set up and test printer hardware. These utilities are activated by pressing FEED button (📄) then turning on the printer power (🔌) simultaneously and release the button at different positions of LED indicator.



4.1 Power-on Utility for Standard Panel

Please follow the steps below for different power-on utilities.

1. Turn off the printer power switch.
2. Hold on the FEED button (📄) then turn on the power switch (🔌).
3. Release the power switch (🔌) when **i** LED color turn on amber.





Note: In this moment, you should still hold on the FEED button.

4. The printer will beep sound twice later, then release the button (📄) when battery LED indicates with different positions for each function.



<i>Power on utilities for standard panel</i>	The battery LED light will be changed as following.		
LED	 (5 blinks)	→  (5 blinks)	→  (5 blinks)
Release FEED button (📄) for different functions	Media sensor calibration (Please refer to 4.1.1)	Media sensor calibration, self-test and enter dump mode (Please refer to 4.1.2)	Printer initialization (Please refer to 4.1.3)

4.1.1 Media Sensor Calibration

Please follow the steps below to calibrate the media sensor.



1. Turn off the printer power switch.
2. Hold on the FEED button () then turn on the power switch () .
3. Release the power switch () when  LED color turn on amber.

Note: In this moment, you should still hold on the FEED button.

4. The printer will beep sound twice later, then release the FEED button () when the indicator becomes  and blinking.
5. Printer will calibrate the gap/black mark sensor sensitivity.





Note: You also can do this function by open/close the media cover when turn on the printer.

- The LEDs will be changed as following figures:



Beep sound twice →  (5 blinks) →  (5 blinks) →  (5 blinks) → Turn on the printer

4.1.2 Self-test and Dump Mode

Please follow the steps below.



1. Turn off the printer power switch.
2. Hold on the FEED button () then turn on the power switch () .
3. Release the power switch () when  LED color turn on amber.

Note: In this moment, you should still hold on the FEED button.

4. The printer will beep sound twice later, then release the FEED button () when the indicator becomes  and blinking.
5. Printer will calibrate the sensor and print out the internal settings, then enter the dump mode.

Note: Turn off/on the power or press FEED button to resume printer from dump mode to normal printing mode. Please refer to [sections 4.3](#) and [4.4](#) for more details of self-test and dump mode.





- The LEDs will be changed as following figures:

Beep sound twice →  (5 blinks) →  (5 blinks) →  (5 blinks) → Turn on the printer



4.1.3 Printer Initialization

Printer initialization is used to clear DRAM and restore printer settings to defaults.

Printer initialization is activated by the following procedures.



1. Turn off the printer power switch.
2. Hold on the FEED button () then turn on the power switch ()
3. Release the power switch () when  LED color turn on amber.

Note: In this moment, you should still hold on the FEED button.

4. The printer will beep sound twice later, then release the FEED button () when the indicator becomes  and blinking.
5. Printer will restore printer settings to defaults.

Note: Please refer to [section 4.5](#) for printer defaults.

- The LEDs will be changed as following figures:

Beep sound twice →  (5 blinks) →  (5 blinks) →  (5 blinks) → Turn on the printer

4.2 Power-on Utility for LCD Panel (Option)

Please follow the steps below for different power-on utilities.

1. Turn off the printer power switch.
2. Hold on the FEED button (📄) then turn on the power switch (🔌).
3. Release the power switch (🔌) when “Error” LED color turn on red.

Note: In this moment, you should still hold on the FEED button.

4. The printer will beep sound twice later, then release the button (📄) when LCD indicate for different functions.

<i>Power on utilities for LCD panel</i>	The LCD will be changed as following.		
LCD	<div style="border: 1px solid black; background-color: #e0ffe0; padding: 5px; text-align: center;">Calibrate.....</div> <p style="text-align: center;">(5 dots)</p>	<div style="border: 1px solid black; background-color: #e0ffe0; padding: 5px; text-align: center;">Self Test.....</div> <p style="text-align: center;">(5 dots)</p>	<div style="border: 1px solid black; background-color: #e0ffe0; padding: 5px; text-align: center;">Initialize.....</div> <p style="text-align: center;">(5 dots)</p>
Release FEED button (📄) for different functions	Media sensor calibration (Please refer to 4.2.1)	Media sensor calibration, self-test and enter dump mode (Please refer to 4.2.2)	Printer initialization (Please refer to 4.2.3)

4.2.1 Media Sensor Calibration

Please follow the steps below to calibrate the media sensor.

1. Turn off the printer power switch.
2. Hold on the FEED button (📄) then turn on the power switch (🔌).
3. Release the power switch (🔌) when “Error” LED color turn on red.

Note: In this moment, you should still hold on the FEED button.

4. The printer will beep sound twice later, then release the FEED button (📄) when LCD showing “Calibrate.....”.
5. Printer will calibrate the gap/black mark sensor sensitivity.

Note: You also can do this function by open/close the media cover when turn on the printer.

- The LCD will be changed as following:
Beep sound twice → **Calibrate..... (5 dots)** → Self Test..... (5 dots) → Initialize..... (5 dots) → Turn on the printer

4.2.2 Self-test and Dump Mode

Please follow the steps below.

1. Turn off the printer power switch.
2. Hold on the FEED button (📄) then turn on the power switch (🔌).
3. Release the power switch (🔌) when “Error” LED color turn on red.

Note: In this moment, you should still hold on the FEED button.

4. The printer will beep sound twice later, then release the FEED button (📄) when LCD showing “Self Test.....”.
5. Printer will calibrate the sensor and print out the internal settings, then enter the dump mode.

Note: Turn off/on the power or press FEED button to resume printer for normal printing. (Ready mode) Please refer to [sections 4.3](#) and [4.4](#) for more details.



- The LCD will be changed as following figures:

Beep sound twice → Calibrate..... (5 dots) → **Self Test..... (5 dots)** → Initialize..... (5 dots) → Turn on the printer

4.2.3 Printer Initialization

Printer initialization is used to clear DRAM and restore printer settings to defaults.

Printer initialization is activated by the following procedures.

1. Turn off the printer power switch.
2. Hold on the FEED button () then turn on the power switch () .
3. Release the power switch () when “Error” LED color turn on red.

Note: In this moment, you should still hold on the FEED button.

4. The printer will beep sound twice later, then release the FEED button () when the LCD showing “Initialize.....”.
5. Printer will restore printer settings to defaults.

Note: Please refer to [section 4.5](#) for printer defaults.

- The LCD will be changed as following figures:

Beep sound twice → Calibrate..... (5 dots) → Self Test..... (5 dots) → **Initialize..... (5 dots)** → Turn on the printer

4.3 Self-test

Printer will print the printer configuration after media sensor calibration. Self-test printout can be used to check if there is any dot damage on the heater element, printer configurations and available memory space.

Note: Self-test printout requires 4" wide paper width.

```

PRINTER INFO.
Model name Version: X.XX EZ
SERIAL NO.:
MILAGE(m): 2
CHECKSUM: 075AC29C
SERIAL PORT: 9600,N,8,1
CODE PAGE: 850
COUNTRY CODE: 001
SPEED: 2 INCH
DENSITY: 8.0
SIZE: 4.00 , 5.99
GAP: 0.12 , 0.00
TRANSPARENCE: 6
VOLTAGE: 7.05 V
TEMPERATURE: 31 °C
RESISTANCE: 179 ohm
BAD DOT(S): 0
*****
BT ADDRESS: 00190EA07ADD
BT NAME: BT-SPP
BT PIN CODE: 0000
*****
WLAN MAC ADDRESS: 00-1D-C9-90-FA-F4
WLAN MODE: INFRASTRUCTURE
WLAN SSID:
WLAN DHCP ENABLED: YES
WLAN IP ADDRESS: 0.0.0.0
WLAN SUBNET MASK: 0.0.0.0
WLAN DEFAULT GATEWAY: 0.0.0.0
*****
FILE LIST:
DRAM FILE: 0 FILE(S)
FLASH FILE: 0 FILE(S)
PHYSICAL DRAM: XXXX KBYTES
AVAILABLE DRAM: XXXX KBYTES FREE
PHYSICAL FLASH: XXXXX KBYTES
AVAILABLE FLASH: XXXXX KBYTES FREE
END OF FILE LIST
*****

```

Printer model name & Main board firmware version
 Printer serial number
 Printed mileage
 Main board firmware checksum
 Serial port setting
 Code page
 Country code
 Print speed
 Print darkness
 Label size (width, height)
 Gap/Black mark (vertical gap, offset)
 Sensor sensitivity
 Battery voltage
 Print head temperature
 Print head average resistance
 Bad dots of print head

Bluetooth settings information

WiFi settings information (option)

File management information

Print head test pattern

4.4 Dump mode

Printer will enter dump mode after printing printer configuration. In the dump mode, all characters will be printed in 2 columns as following. The left side characters are received from your system and right side data are the corresponding hexadecimal value of the characters. It allows users or engineers to verify and debug the program.

ASCII Data	→	<pre> SPEED 2.0 53 50 45 45 44 20 32 2E 30 0D DENSITY 8 0A 44 45 4E 53 49 54 59 20 38 SET PEEL 0D 0A 53 45 54 20 50 45 45 4C OFF DIRE 20 4F 46 46 0D 0A 44 49 52 45 CTION 0 0 43 54 49 4F 4E 20 30 0D 0A 47 AP 3.00 mm 41 50 20 33 2E 30 30 20 6D 6D .0.00 mm 2C 30 2E 30 30 20 6D 6D 0D 0A REFERENCE 52 45 46 45 52 45 4E 43 45 20 0.0 SET C 30 2C 30 0D 0A 53 45 54 20 43 UTTER OFF 55 54 54 45 52 20 4F 46 46 0D SIZE 100. 0A 53 49 5A 45 20 31 30 30 2E 02 mm.65.0 30 32 20 6D 6D 2C 36 35 2E 30 4 mm CLS 34 20 6D 6D 0D 0A 43 4C 53 0D BARCODE 1 0A 42 41 52 43 4F 44 45 20 31 44,149,"39 34 34 2C 31 34 39 2C 22 33 39 ",120,"1,0 22 2C 31 32 30 2C 31 2C 30 2C 2.6,"57114 32 2C 36 2C 22 35 37 31 31 34 38T" PRIN 33 38 54 22 0D 0A 50 52 49 4E T 1,1 SPE 54 20 31 2C 31 0D 0A 53 50 45 ED 2.0 DE 45 44 20 32 2E 30 0D 0A 44 45 NSITY 8 S 4E 53 49 54 59 20 38 0D 0A 53 </pre>	← Hex decimal data related to left column of ASCII data
		<pre> ET PEEL OF 45 54 20 50 45 45 4C 20 4F 46 F DIRECTI 46 0D 0A 44 49 52 45 43 54 49 ON 0 9AP 4F 4E 20 30 0D 0A 47 41 50 20 3.00 mm.0. 33 2E 30 30 20 6D 6D 2C 30 2E 00 mm REF 30 30 20 6D 6D 0D 0A 52 45 46 ERENCE 0.0 45 52 45 4E 43 45 20 30 2C 30 SET CUTT 0D 0A 53 45 54 20 43 55 54 54 ER OFF SI 45 52 20 4F 46 46 0D 0A 53 49 ZE 100.02 5A 45 20 31 30 30 2E 30 32 20 mm.65.04 m 6D 6D 2C 36 35 2E 30 34 20 0D m CLS BA 6D 0D 0A 43 4C 53 0D 0A 42 41 RCODE 144, 52 43 4F 44 45 20 31 34 34 2C 149,"39",1 31 34 39 2C 22 33 39 22 2C 31 20,"1,0,2,0 32 30 2C 31 2C 30 2C 32 2C 36 :"5711438T 2C 22 35 37 31 31 34 33 38 54 ,1 PRINT 1 22 0D 0A 50 52 49 4E 54 20 31 ,1 2C 31 0D 0A </pre>	

Note:

1. Dump mode requires 4" wide paper width.
2. Turn off / on the power or press FEED button to resume printer for normal printing. (Ready mode)

4.5 Printer defaults

Printer configuration will be restored to defaults as below after initialization.

Parameter	Default setting
Speed	50.8 mm/sec (2 ips)
Density	8
Media Width	4" (101.5 mm)
Media Height	4" (101.5 mm)
Sensor Type	Gap sensor
Print Direction	0
Reference Point	0,0 (upper left corner)
Gap Offset	0
Post-Print Action	Tear mode
Serial Port Settings	9600 bps, none parity, 8 data bits, 1 stop bit
Code Page	850
Country Code	001
Clear Flash Memory	No

Note:

When printer initialization is done, please calibrate the gap or black mark sensor before printing.

5. Diagnostic Tool

TSC's Diagnostic Utility is an integrated tool incorporating features that enable you to explore a printer's settings/status; change a printer's settings; download graphics, fonts and firmware; create a printer bitmap font; and send additional commands to a printer. With the aid of this powerful tool, you can review printer status and setting in an instant, which makes it much easier to troubleshoot problems and other issues.

5.1 Start the Diagnostic Tool

1. Double click on the Diagnostic tool icon  `Diag Tool.exe` to start the software.
2. There are four features (Printer Configuration, File Manager, Bitmap Font Manager, Command Tool) included in the Diagnostic utility.

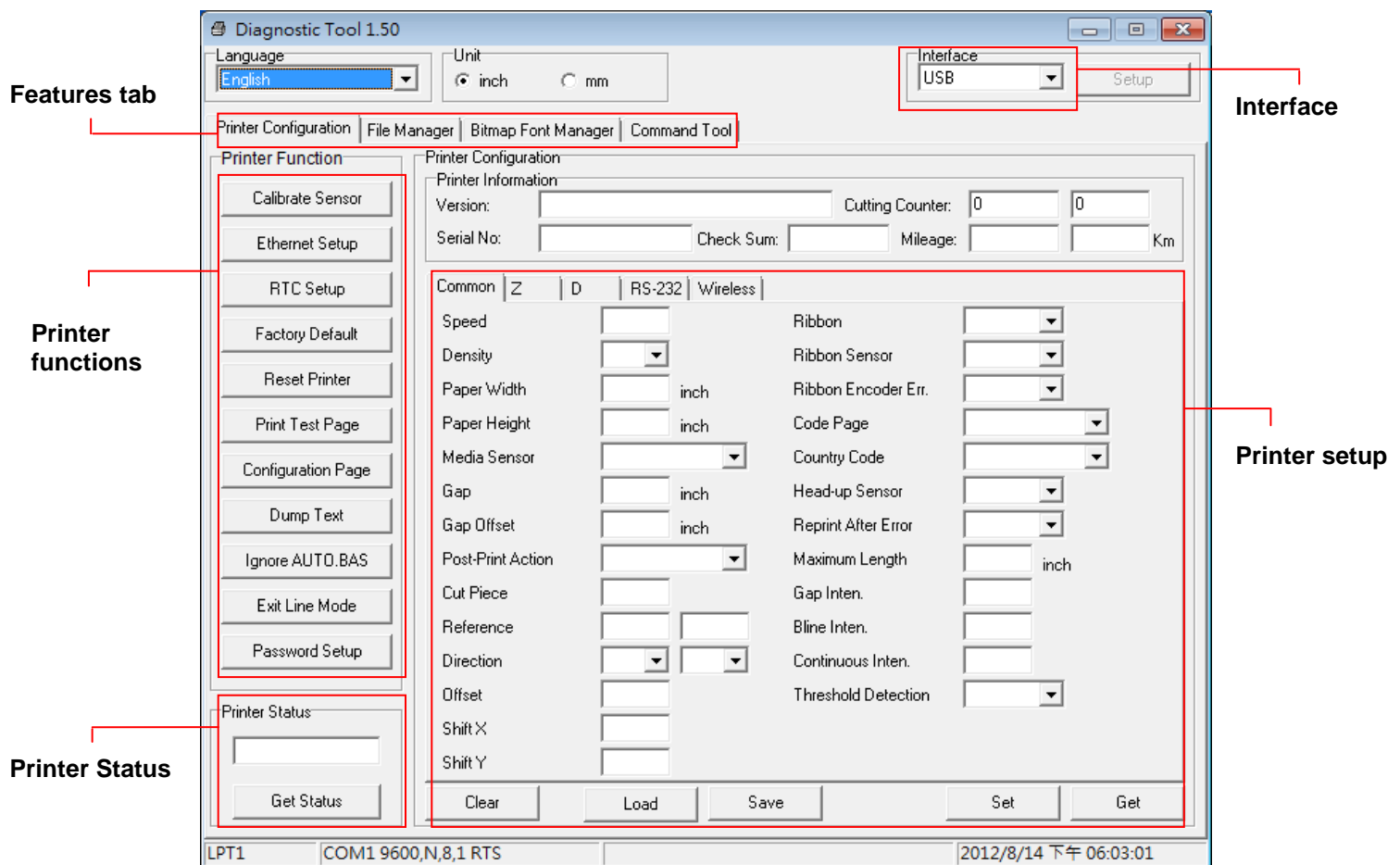

5.2 Printer Function

1. Connect the printer and computer with a cable.

Note:

* The printer connects with the computer via USB to USB cable or USB to RS-232 cable (option).

2. Select the PC interface connected with bar code printer.

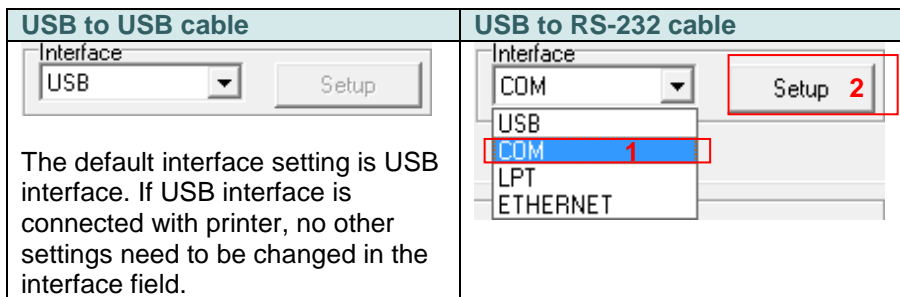

3. Click the “Printer Function” button to setup.
4. The detail functions in the Printer Function Group are listed as below.

Printer Function	Function	Description
Calibrate Sensor	Calibrate Sensor	Calibrate the sensor specified in the Printer Setup group media sensor field
Ethernet Setup	Ethernet Setup	Setup the IP address, subnet mask, gateway for the on board Ethernet
RTC Setup	RTC Setup	Synchronize printer Real Time Clock with PC
Factory Default	Factory Default	Initialize the printer and restore the settings to factory default.
Reset Printer	Reset Printer	Reboot printer
Print Test Page	Print Test Page	Print a test page
Configuration Page	Configuration Page	Print printer configuration
Dump Text	Dump Text	To activate the printer dump mode.
Ignore AUTO.BAS	Ignore AUTO.BAS	Ignore the downloaded AUTO.BAS program
Exit Line Mode	Exit Line Mode	Exit line mode.
Password Setup	Password Setup	Set the password to protect the settings

For more information about Diagnostic Tool, please refer to the diagnostic utility quick start guide in the CD disk \ Utilities directory.

5.3 Setting Bluetooth by Diagnostic Tool

1. Connect the printer and computer with a cable.

Note:

* The printer connects with the computer via USB to USB cable or USB to RS-232 cable (option).

2. Turn on the printer power switch.
3. Open Diagnostic tool and set interface. (The default setting is USB)

USB to USB cable	USB to RS-232 cable
<p>Interface USB <input type="button" value="Setup"/></p> <p>The default interface setting is USB interface. If USB interface is connected with printer, no other settings need to be changed in the interface field.</p>	<p>Interface COM <input type="button" value="Setup"/> 2</p> <p>USB COM 1 LPT ETHERNET</p>

4. Select “Wireless” tab and click on “Built-in wireless module” item.
5. Enter the new BT Local Name or BT PIN Code in the editor.
6. Press “Set” button to set the new BT name or BT PIN code of the printer.
7. Press “Get” button to get back the settings. Make sure the Bluetooth module settings are set properly.

Common | Z | D | RS-232 | **Wireless** **1**

Device Type
 Built-in wireless module **2** External wireless module

Built-in wireless module

Bluetooth Local Name: BT-SPP
Bluetooth PIN Code: 0000 **3**

WLAN SSID:
WLAN Encryption:
WLAN Key:
WLAN DHCP:
WLAN IP Address: 0.0.0.0
WLAN Subnet Mask: 0.0.0.0
WLAN Gateway: 0.0.0.0

Clear Load Save **Set** **4** **Get** **5**

5.4 Setting Wi-Fi by Diagnostic Tool (Option)

1. Connect the printer and computer with the cable.

Note:

* The printer connects with the computer via USB to USB cable or USB to RS-232 cable (option).

2. Turn on the printer power switch.
3. Open Diagnostic tool and set interface. (The default setting is USB.)

USB to USB cable	USB to RS-232 cable
Interface <input type="text" value="USB"/> <input type="button" value="Setup"/> <p>The default interface setting is USB interface. If USB interface is connected with printer, no other settings need to be changed in the interface field.</p>	Interface <input type="text" value="COM"/> <input type="button" value="Setup"/> 2 <input type="text" value="USB"/> <input type="text" value="COM"/> 1 <input type="text" value="LPT"/> <input type="text" value="ETHERNET"/>

4. Select “Wireless” tab and click on “Built-in wireless module” item.
5. Enter the new WLAN settings in the editor.
6. Press “Set” button to set the new settings to the printer.
7. The Wi-Fi LED will turn on blue (the Wi-Fi icon will be shown for LCD panel) if device has been connected.
8. Print out the self-test page to confirm if it’s connected with right settings.
9. Remove the cable to print a data for test.

Common | Z | D | RS-232 | **Wireless** **1**

Device Type
 Built-in wireless module **2** External wireless module

Built-in wireless module

Bluetooth Local Name	<input type="text"/>	WLAN SSID	<input type="text" value="Dlink"/>
Bluetooth PIN Code	<input type="text"/>	WLAN Encryption	<input type="text"/>
		WLAN Key	<input type="text"/>
		WLAN DHCP	<input type="text" value="ON"/> 3
		WLAN IP Address	<input type="text" value="0.0.0.0"/>
		WLAN Subnet Mask	<input type="text" value="0.0.0.0"/>
		WLAN Gateway	<input type="text" value="0.0.0.0"/>

Clear Load Save **4** **5**

6. LCD Menu Function (Option)

The Alpha-4L series offer the LCD panel for selection to further enhance its capabilities to meet the demands of a wide range of printing solutions. This option feature includes LCD control panel, 4 buttons and 2 LED display. Please press the “M” button to enter the setting menu.

6.1 How to use the LCD to set the printer

Press the “M” button to display the function menu screen as following shown.

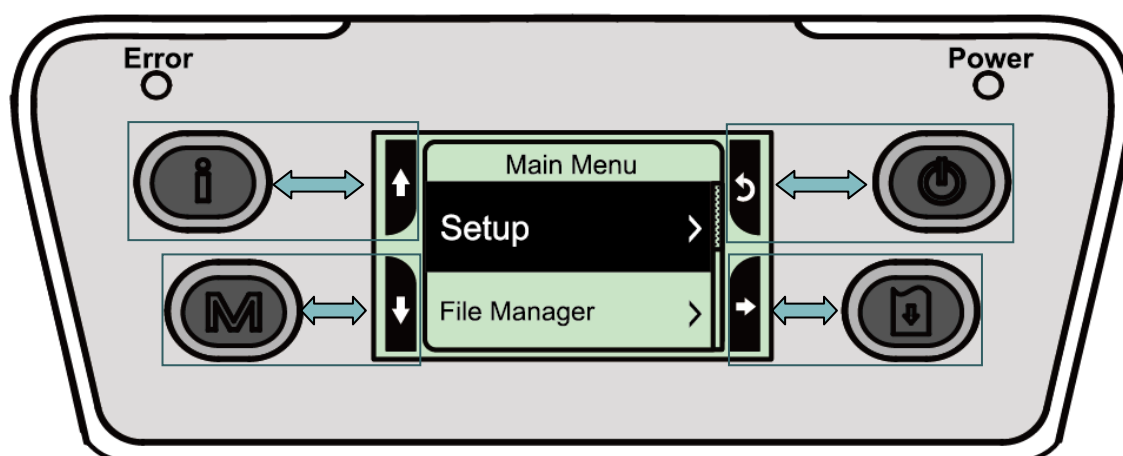

You can use this 4 buttons to scroll, select, enter or return the menu, depend on the icons from 4-sides of LCD. It was selected if the item with the black ground on the screen. The icon function is listed as below,

Icon	Function
	Display printer information
	Enter setting menu
	Power switch
	Scroll up
	Scroll down
	Return to previous menu
	Enter to next menu
	Enter setting mode
	Exit setting mode
	Save the selected settings and return to previous menu
	Select
	Alter to OFF
	Alter to ON

For example:

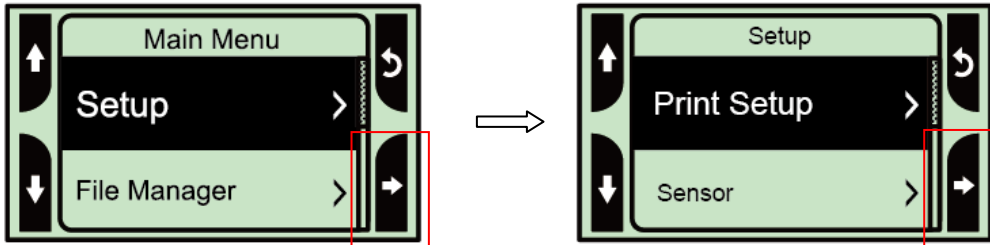

Change the speed setting, please following steps as below.

1. Press “M” button to enter the setting menu. Press  button to enter the “Setup” item.

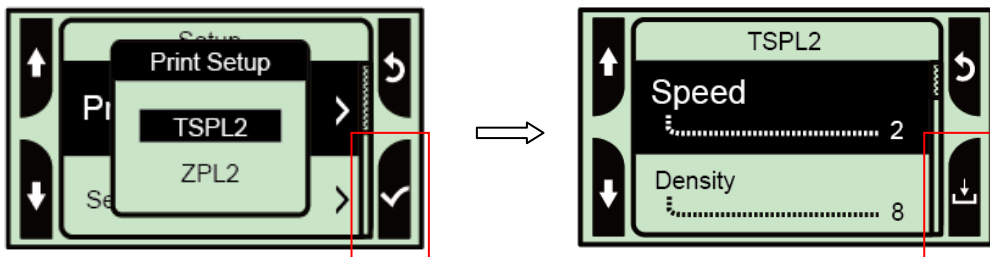

2. Press  button to enter the “Print Setup” item. Select the “TSPL2” item. Enter the “Speed” setting mode.



3. At this status, you can scroll up or scroll down to select the value of print speed. Then press the  button to save the selected value into the printer. Press “” button to back to “Ready mode”.

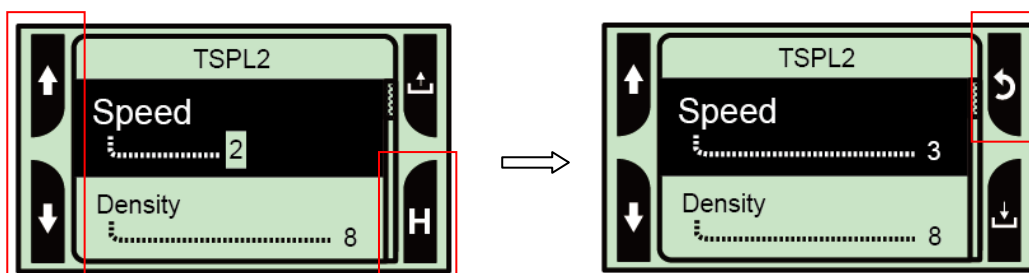

6.2 Main Menu Overview

There are 5 categories for the main menu. You can easily set the settings of printer without connecting the computer. Please refer to following sections for more details.

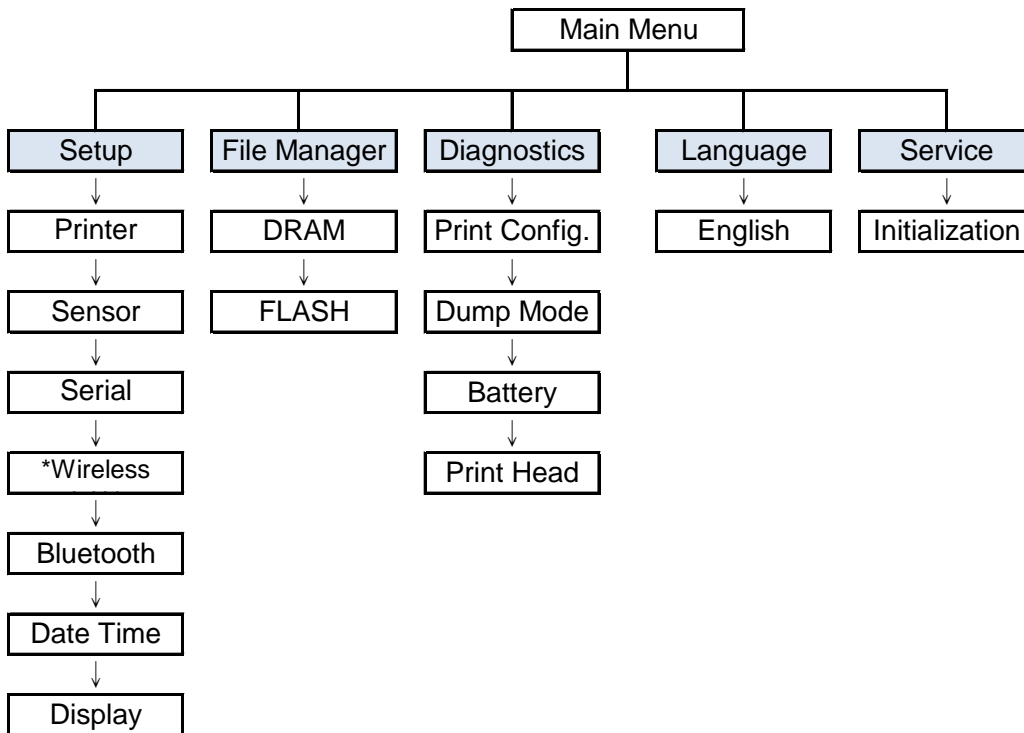

Note:

* The Wireless LAN function is optional for Alpha-4L series.

6.3 Setup

This “Setup” category can set up the sensor, serial comm., wireless, Bluetooth, date time and display settings.

6.3.1 Printer Setup

6.3.1-1 Printer setup for TSPL2

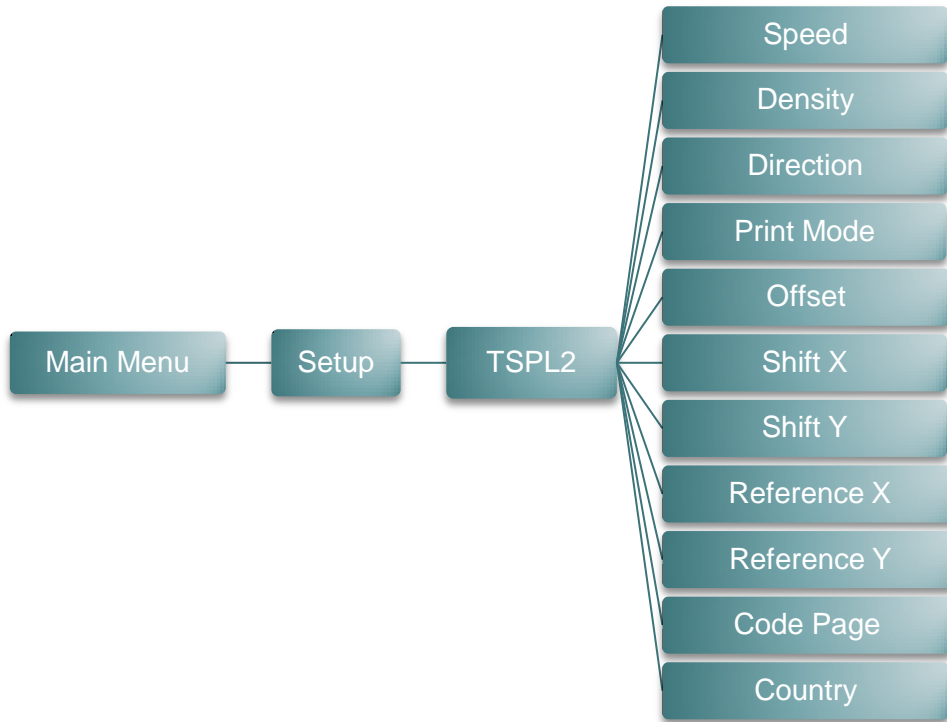

Item	Description	Default				
Speed	Use this item to setup print speed. The each increase or decrease is 0.5 ips. Available setting is from 1 to 6.	2				
Density	Use this option to setup printing darkness. The available setting is from 0 to 15, and the step is 1. You may need to adjust your density based on selected media.	8				
Direction	<p>The direction setting value is either 1 or 0. Use this item to setup the printout direction.</p> <div style="border: 1px solid black; padding: 5px; text-align: center;"> <table style="width: 100%; border-collapse: collapse;"> <tr> <td style="width: 50%; border-bottom: 1px solid black; text-align: center;">DIRECTION 0</td> <td style="width: 50%; border-bottom: 1px solid black; text-align: center;">DIRECTION 1</td> </tr> <tr> <td style="border: 1px solid black; text-align: center; padding: 10px;">Direction</td> <td style="border: 1px solid black; text-align: center; padding: 10px;">Direction</td> </tr> </table> </div>	DIRECTION 0	DIRECTION 1	Direction	Direction	0
DIRECTION 0	DIRECTION 1					
Direction	Direction					

Print mode	This item is used to set the print mode. There are 3 modes as below,		Batch Mode
	Printer Mode	Description	
	None	Next label top of form is aligned to the print head burn line location. (Tear Off Mode)	
	Batch Mode	Once image is printed completely, label gap/black mark will be fed to the tear plate location for tear away.	
Peeler Mode	Enable the label peel off mode.		
Offset	This item is used to fine tune media stop location. Available setting value is from "+" to "-" or "0" to "9".		+000
Shift X	This item is used to fine tune print position. Available setting value is from "+" to "-" or "0" to "9".		+000
Shift Y			+000
Reference X	This item is used to set the origin of printer coordinate system horizontally and vertically. Available setting value is from "0" to "9".		000
Reference Y			000
Code page	Use this item to set the code page of international character set.		850
Country	Use this option to set the country code.		001

Note: If printing from enclosed software/driver, the software/driver will send out the commands, which will overwrite the settings set from the panel.

6.3.1-2 Printer setup for ZPL2

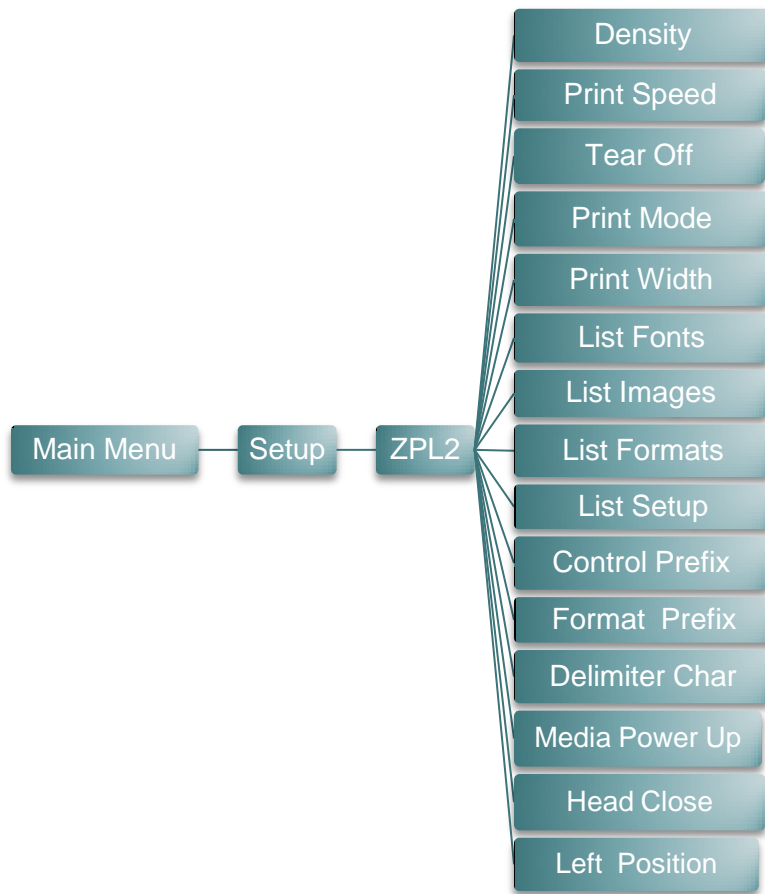

Item	Description	Default						
Density	Use this item to setup printing darkness. The available setting is from 0 to 30, and the step is 1. You may need to adjust your density based on selected media.	16						
Print Speed	Use this item to setup print speed. The each increase or decrease is 1 ips. Available setting is from 1 to 6.	2						
Tear Off	This item is used to fine tune media stop location. Available setting value is from “+” to “-” or “0” to “9”.	+000						
Print mode	<p>This item is used to set the print mode. There are 2 modes as below,</p> <table border="1"> <thead> <tr> <th>Printer Mode</th> <th>Description</th> </tr> </thead> <tbody> <tr> <td>Tear Off Mode</td> <td>Next label top of form is aligned to the print head burn line location.</td> </tr> <tr> <td>Peeler Mode</td> <td>Enable the label peel off mode.</td> </tr> </tbody> </table>	Printer Mode	Description	Tear Off Mode	Next label top of form is aligned to the print head burn line location.	Peeler Mode	Enable the label peel off mode.	Tear Off
Printer Mode	Description							
Tear Off Mode	Next label top of form is aligned to the print head burn line location.							
Peeler Mode	Enable the label peel off mode.							
Print Width	This item is used to set print width. The available value is from “0” to “9”.	812						
List Fonts	This feature is used to print current printer available fonts list to	N/A						

	the label. The fonts stored in the printer's DRAM, Flash or optional memory card.											
List Images	This feature is used to print current printer available images list to the label. The images stored in the printer's DRAM, Flash or optional memory card.	N/A										
List Formats	This feature is used to print current printer available formats list to the label. The formats stored in the printer's DRAM, Flash or optional memory card.	N/A										
List Setup	This feature is used to print current printer configuration to the label.	N/A										
Control Prefix	This feature is used to set control prefix character.	N/A										
Format Prefix	This feature is used to set format prefix character.	N/A										
Delimiter Char	This feature is used to set delimiter character.	N/A										
Media Power Up	<p>This option is used to set the action of the media when you turn on the printer.</p> <table border="1"> <thead> <tr> <th>Selections</th> <th>Description</th> </tr> </thead> <tbody> <tr> <td>Feed</td> <td>Printer will advance one label</td> </tr> <tr> <td>Calibration</td> <td>Printer will calibration the sensor levels, determine length and feed label</td> </tr> <tr> <td>Length</td> <td>Printer determine length and feed label</td> </tr> <tr> <td>No Motion</td> <td>Printer will not move media</td> </tr> </tbody> </table>	Selections	Description	Feed	Printer will advance one label	Calibration	Printer will calibration the sensor levels, determine length and feed label	Length	Printer determine length and feed label	No Motion	Printer will not move media	No Motion
Selections	Description											
Feed	Printer will advance one label											
Calibration	Printer will calibration the sensor levels, determine length and feed label											
Length	Printer determine length and feed label											
No Motion	Printer will not move media											
Head Close	<p>This option is used to set the action of the media when you close the print head.</p> <table border="1"> <thead> <tr> <th>Selections</th> <th>Description</th> </tr> </thead> <tbody> <tr> <td>Feed</td> <td>Printer will advance one label</td> </tr> <tr> <td>Calibration</td> <td>Printer will calibration the sensor levels, determine length and feed label</td> </tr> <tr> <td>Length</td> <td>Printer determine length and feed label</td> </tr> <tr> <td>No Motion</td> <td>Printer will not move media</td> </tr> </tbody> </table>	Selections	Description	Feed	Printer will advance one label	Calibration	Printer will calibration the sensor levels, determine length and feed label	Length	Printer determine length and feed label	No Motion	Printer will not move media	No Motion
Selections	Description											
Feed	Printer will advance one label											
Calibration	Printer will calibration the sensor levels, determine length and feed label											
Length	Printer determine length and feed label											
No Motion	Printer will not move media											
Label Top	This option is used to adjust print position vertically on the label. The range is -120 to +120 dots.	0										
Left Position	This option is used to adjust print position horizontally on the label. The range is -9999 to +9999 dots.	+0000										

Note: If printing from enclosed software/driver, the software/driver will send out the commands, which will overwrite the settings set from the panel.

6.3.2 Sensor

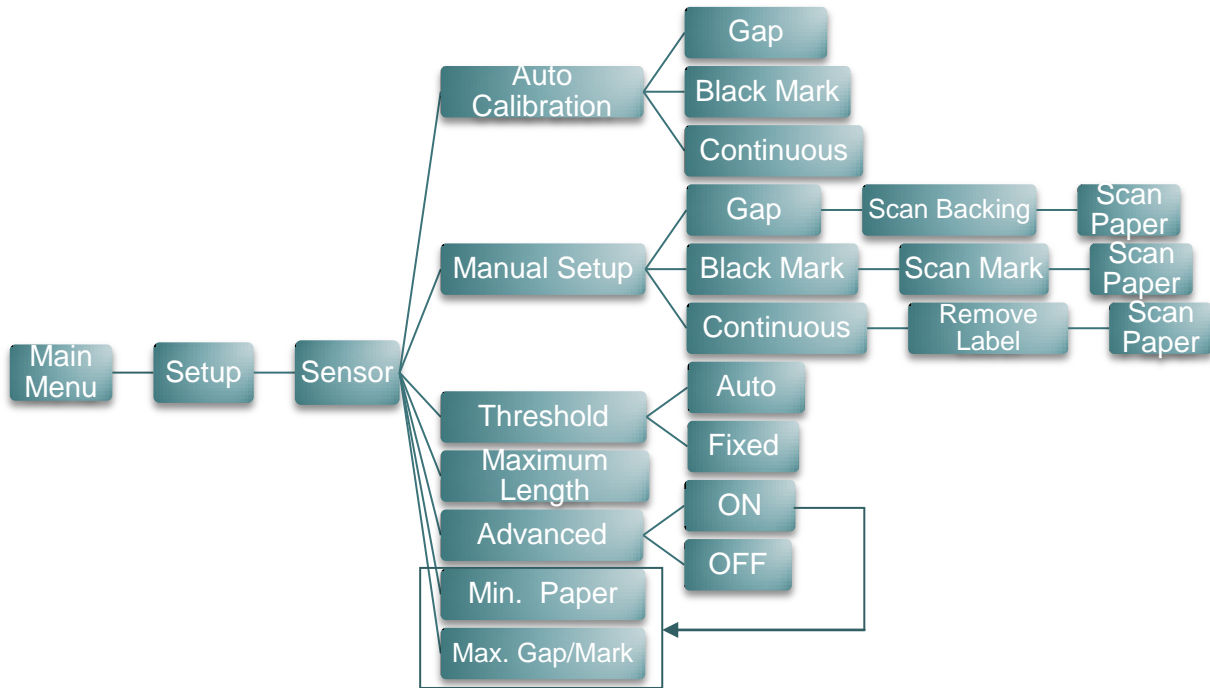

Item	Description	Default
Auto Calibration	This item is used to set the media sensor type and calibrate the selected sensor. Printer will feed 2 to 3 gap labels to calibrate the sensor sensitivity automatically.	N/A
Manual Setup	In case “Auto Calibration” cannot apply to the media, please use “Manual Setup” function to calibrate the sensor manually. Please follow the shown step from LCD to do. Note: You can open the media cover to move the paper but have to close the media cover for each scan.	N/A
Threshold	This item is used to fix the calibrated sensor sensitivity.	Auto
Maximum Length	This item is used to set the max. calibrate length.	152
Advanced	This item is used for pre-printed paper. If this advanced function is turned “ON” then you can setup the min. paper and max. gap/black mark size.	OFF

6.3.3 Serial Comm.

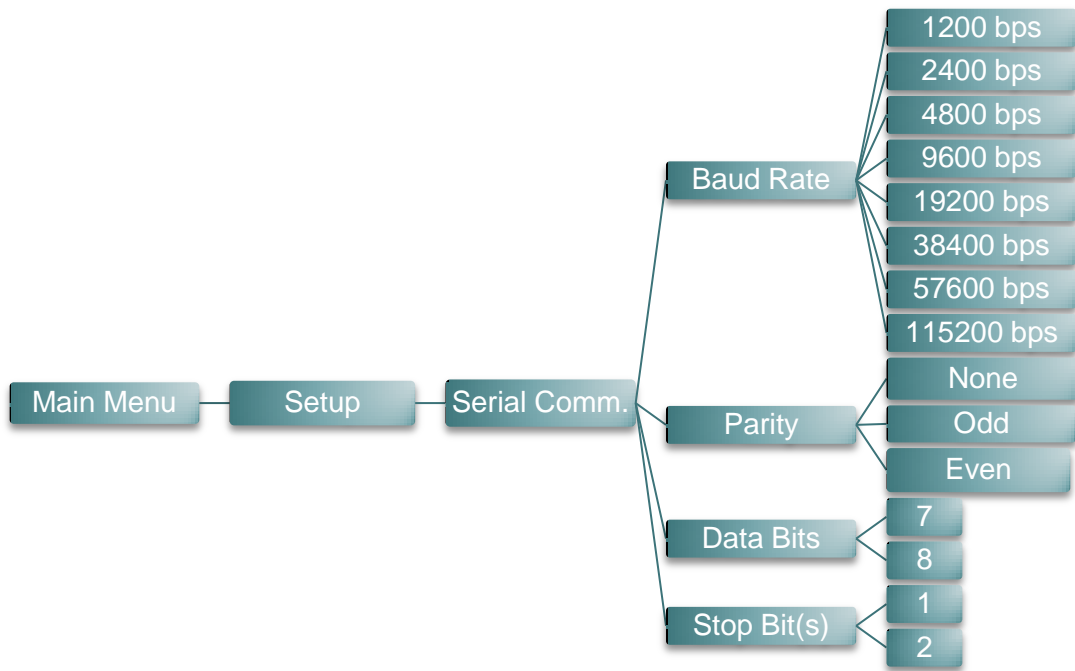

Item	Description	Default
Baud Rate	This item is used to set the RS-232 baud rate.	9600
Parity	This item is used to set the RS-232 parity.	None
Data Bits	This item is used to set the RS-232 Data Bits.	8
Stop Bit(s)	This item is used to set the RS-232 Stop Bits.	1

6.3.4 Wireless LAN

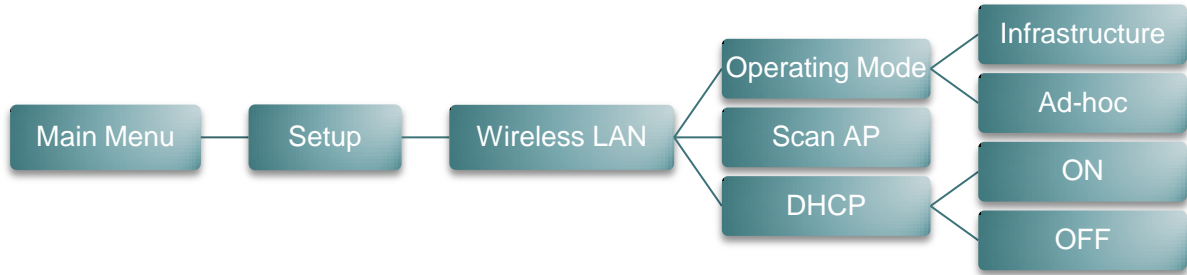

Item	Description	Default
Operating Mode	<p>This item is used to set the operating mode of wireless local area networks to connect devices to the networks.</p> <p>Note: Infrastructure mode requires the use of an access point for this communication to take place. Ad hoc mode involves connecting a computer directly to another computer.</p>	Infrastructure
Scan AP	This item is used to scan the access point device	N/A
DHCP	This item is used to ON or OFF the DHCP (Dynamic Host Configuration Protocol) network protocol.	ON

6.3.5 Bluetooth

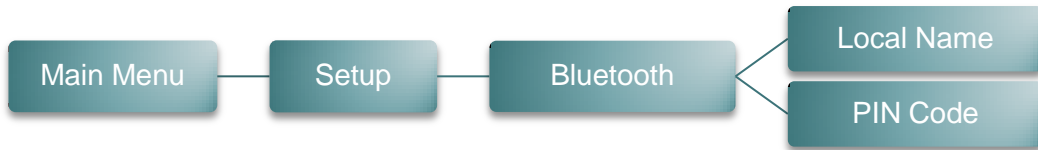

Item	Description	Default
Local Name	This item is used to set the local name for Bluetooth.	BT-SPP
PIN Code	This item is used to set the local PIN code for Bluetooth.	0000

6.3.6 Date Time



Item	Description	Default
Date	This item is used to set the date. (ex: 2013-05-30)	N/A
Time	This item is used to set the time. (ex: 19:20:02)	N/A

6.3.7 Display

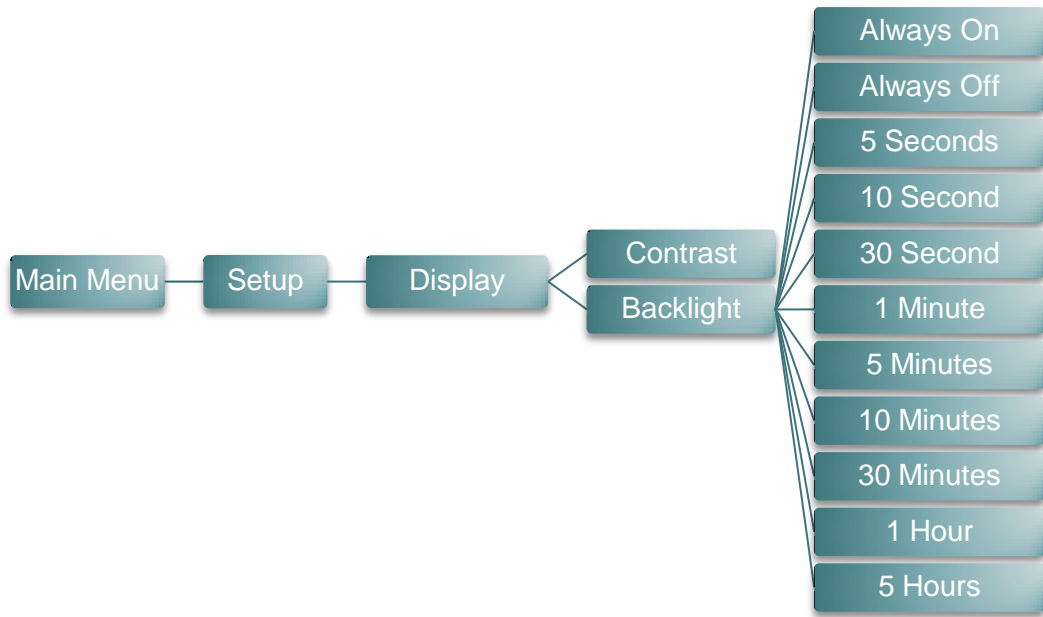

Item	Description	Default
Contrast	This item is used to set the contrast for display.	50
Backlight	This item is used to set the backlight time for display.	10 Seconds

6.4 File Manager

This feature is used to check the printer available memory and file list.

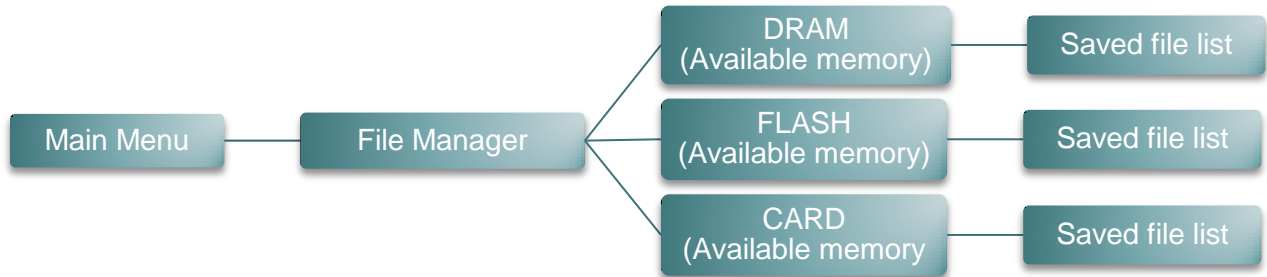

Item	Description
DRAM	Use this menu to show available memory space and run (.BAS) the files saved in the printer DRAM memory.
FLASH	Use this menu to show available memory space and run (.BAS) the files saved in the printer Flash memory.
CARD	Use this menu to show available memory space and run (.BAS) the files saved in the printer MicroSD card memory.

6.5 Diagnostics

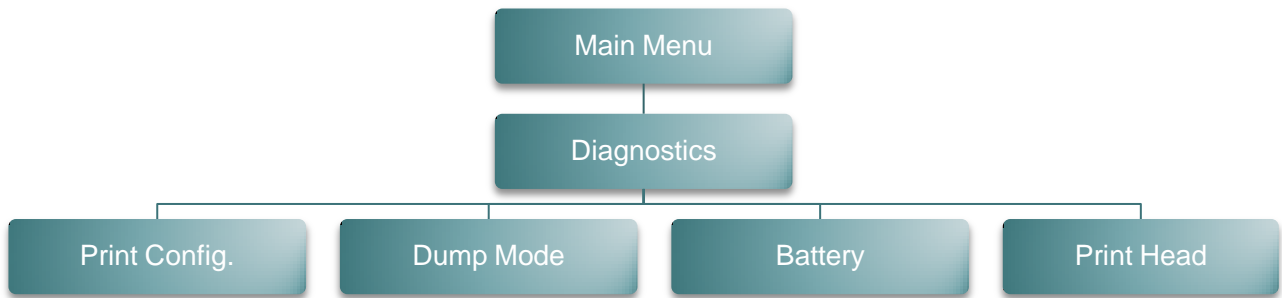

6.5.1 Print Config.



This feature is used to print current printer configuration to the label. On the configuration printout, there is a print head test pattern, which is useful for checking if there is any dot damage on the print head heater element. Please refer to [section 4.3](#) for more details.

6.5.2 Dump Mode



Captures the data from the communications port and prints out the data received by printer. In the dump mode, all characters will be printed in 2 columns. (Please refer to [section 4.4](#)) The left side characters are received from your system and right side data are the corresponding hexadecimal value of the characters. It allows users or engineers to verify and debug the program.

Note:
Dump mode requires 4" wide paper width.

6.5.3 Battery



This feature is used to check the printer battery voltage.

6.5.4 Print Head



This feature is used to check the printer temperature, resistance, and bad dots for print head.

6.6 Language



This option is used to setup the language on LCD display.

6.7 Service



This feature is used to restore printer settings to defaults. Please refer to [section 4.5](#).

Note:

When printer initialization is done, please calibrate the gap or black mark sensor before printing.

7. Troubleshooting

The following guide lists the most common problems that may be encountered when operating this bar code printer. If the printer still does not function after all suggested solutions have been invoked, please contact the Customer Service Department of your purchased reseller or distributor for assistance.

Problem	Possible Cause	Recovery Procedure
Power indicator does not illuminate	<ul style="list-style-type: none"> * The battery is not properly installed. * Battery out of power. * The battery is dead. 	<ul style="list-style-type: none"> * Reinstall the battery. * Switch the printer on. * Charge the battery. * Replace a new battery.
Not Printing	<ul style="list-style-type: none"> * Check if interface cable is well connected to the interface connector. * Check if wireless or Bluetooth device is well connected between host and printer. * The port specified in the Windows driver is not correct. 	<ul style="list-style-type: none"> * Re-connect cable to interface. * Please reset the wireless device setting. * Select the correct printer port in the driver.
No print on the label	<ul style="list-style-type: none"> * Label loaded not correctly. * Use wrong type paper 	<ul style="list-style-type: none"> * Follow the instructions in loading the media. * Use thermal type paper
The printer status from DiagTool or LCD shows " Head Open ".	<ul style="list-style-type: none"> * The printer carriage is open. 	<ul style="list-style-type: none"> * Please close the print carriage.
The printer status from DiagTool or LCD shows " Out of Paper ".	<ul style="list-style-type: none"> * Running out of media roll. * The media is installed incorrectly. * Media sensor is not calibrated. 	<ul style="list-style-type: none"> * Supply a new media roll. * Follow the instructions in loading the media to reinstall the media roll. * Calibrate the media sensor.
The printer status from DiagTool or LCD shows " Paper Jam ".	<ul style="list-style-type: none"> * Media sensor is not set properly. * Make sure media size is set properly. * Label may be stuck inside the printer mechanism. 	<ul style="list-style-type: none"> * Calibrate the media sensor. * Set media size correctly. * Remove the stuck label inside the printer mechanism.
The printer status from LCD shows " Strong light. Press FEED to print. "	<ul style="list-style-type: none"> * Peel-off sensor can't work in strong light place. 	<ul style="list-style-type: none"> * Remove the printer to proper place to print for peer-off mode.
Can't downloading the file to memory (FLASH / DRAM/CARD)	<ul style="list-style-type: none"> * The space of memory is full. 	<ul style="list-style-type: none"> * Delete unused files in the memory. * The max. numbers of DRAM is 256 files. * The max. user addressable memory space of DRAM is 2048KB. * The max. numbers of file of FLASH is 256 files. * The max. user addressable memory space of FLASH is 14336KB.

Poor Print Quality	<ul style="list-style-type: none"> * Media is loaded incorrectly * Dust or adhesive accumulation on the print head. * Print density is not set properly. * Print speed is not set properly. * Print head element is damaged. 	<ul style="list-style-type: none"> * Reload the supply. * Clean the print head. * Clean the platen roller. * Adjust the print density and print speed. * Run printer self-test and check the print head test pattern if there is dot missing in the pattern. * Change proper media roll.
Missing printing on the left or right side of label	<ul style="list-style-type: none"> * Wrong label size setup. 	<ul style="list-style-type: none"> * Set the correct label size.
Gray line on the blank label	<ul style="list-style-type: none"> * The print head is dirty. * The platen roller is dirty. 	<ul style="list-style-type: none"> * Clean the print head. * Clean the platen roller. <p>Please refer to section 8</p>
Irregular printing	<ul style="list-style-type: none"> * The printer is in Hex Dump mode. 	<ul style="list-style-type: none"> * Turn off and on the printer to skip the dump mode.

8. Maintenance

This session presents the clean tools and methods to maintain your printer.

1. Please use one of following material to clean the printer.

- Cotton swab
- Lint-free cloth
- Vacuum / Blower brush
- 100% Ethanol or Isopropyl Alcohol

2. The cleaning process is described as following,

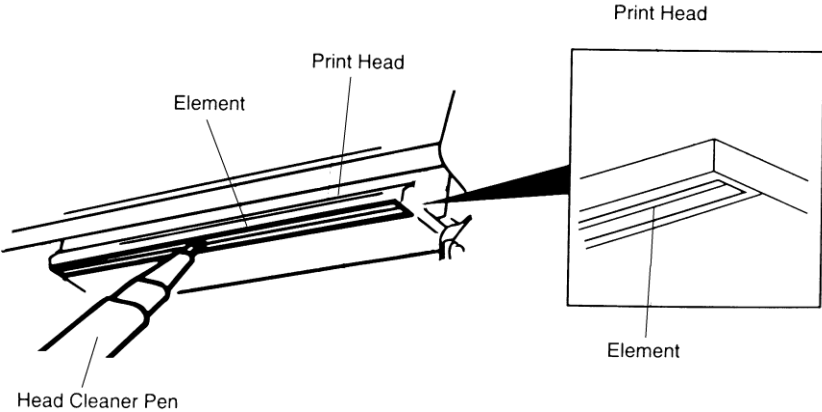
Printer Part	Method	Interval
Print Head	<ol style="list-style-type: none"> 1. Always turn off the printer before cleaning the print head. 2. Allow the print head to cool for a minimum of one minute. 3. Use a cotton swab and 100% Ethanol or Isopropyl Alcohol to clean the print head surface. 	Clean the print head when changing a new label roll.
		
Platen Roller	<ol style="list-style-type: none"> 1. Turn the power off. 2. Rotate the platen roller and wipe it thoroughly with water. 	Clean the platen roller when changing a new label roll
Peel Bar	Use the lint-free cloth with 100% ethanol to wipe it.	As needed
Sensor	Compressed air or vacuum	Monthly
Exterior	Wipe it with water-dampened cloth	As needed
Interior	Brush or vacuum	As needed

Note:

- Do not touch printer head by hand. If you touch it careless, please use ethanol to clean it.
- Please use 100% Ethenol or Isopropyl Alcohol. DO NOT use medical alcohol, which may damage the printer head.
- Regularly clean the print head and supply sensors once change a new media to keep printer performance and extend printer life.

Revise History

Date	Content	Editor
2013/10/4	Modify section 2.3.2	Camille
2013/10/31	Modify section 1.3 and 3.2	Camille
2014/1/8	* Modify section 1.2.2 * Add section 3.6 (Install the adapter for 0.75" and 1" paper core)	Camille
2014/1/23	Modify section 1.3	Camille
2014/4/30	Add section 3.7 (Install the belt strap)	Camille
2014/5/19	Modify section 1.2.2	Camille



TSC Auto ID Technology Co., Ltd.

Corporate Headquarters

9F., No.95, Minquan Rd., Xindian Dist.,
New Taipei City 23141, Taiwan (R.O.C.)
TEL: +886-2-2218-6789
FAX: +886-2-2218-5678
Web site: www.tscprinters.com
E-mail: printer_sales@tscprinters.com
tech_support@tscprinters.com

Li Ze Plant

No.35, Sec. 2, Ligong 1st Rd., Wujie Township,
Yilan County 26841, Taiwan (R.O.C.)
TEL: +886-3-990-6677
FAX: +886-3-990-5577